

Pegasus

The Galaxy range represents a contemporary selection of modern lever designs, mixing clean lines with radiused edging for maximum user comfort.

Rose

- 7201Lever Set
- 7201D.....Dummy Lever
- 7202.....Passage Set
- 7203.....Privacy Set
- 7204Entrance Set
- 7205.....Privacy Set - Integrated

- > **Lever Set**
Includes Levers only
- > **Dummy Set**
Includes single Lever Handle and 1152 Dummy Mount
- > **Passage Set**
Includes Levers and 1357 Tubular Latch - 60mm backset
- > **Privacy Set**
Includes Levers, 1357 Tubular Latch (60mm backset) and 9034 Privacy Bolt, Turn and Escape
- > **Entrance Set**
Includes Levers, 1143 Euro Mortice Lock, 9035/9045 Escutcheons and 1148 Euro Cylinder and Turn
- > **Integrated Privacy Set**
Includes Levers and 1358 Tubular Privacy Latch - 60mm backset

Galaxy

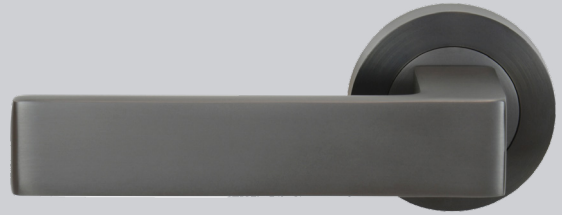

Dimensions

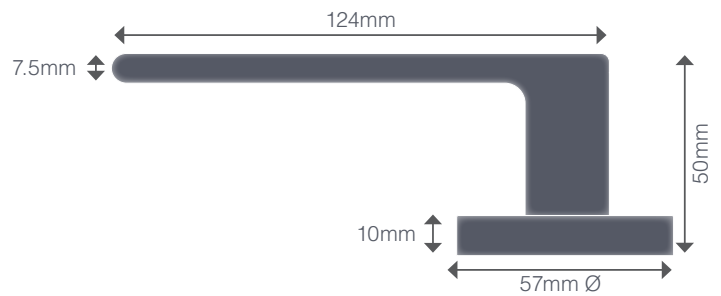
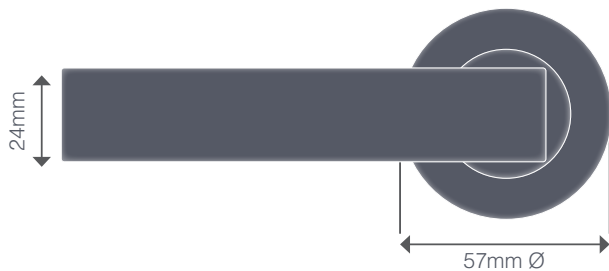

Specs

- > Constructed from zinc alloy
- > Includes rapidFIT installation system, increasing both install speed, overall strength, and stability.
- > Suits door thicknesses of 32–55mm
- > For door thicknesses that exceed this, custom spindles and alternative fixings will need to be sourced
- > Suitable for interior and exterior use

Installation

- > 60mm backset (see diagram)
- > 48mm hole for rapidFIT
- > Passage Set installation shown

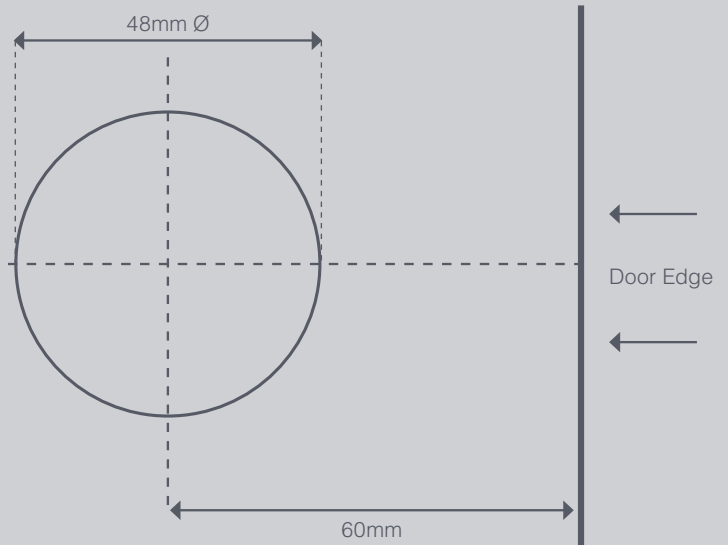
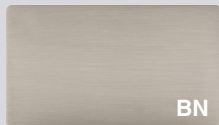

Diagram is not to scale, please refer to fitting instructions [here](#).

Finishes

Stocked



BN

Brushed Nickel

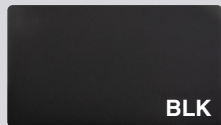

BLK

Matt Black

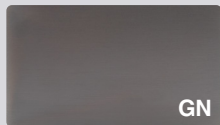

GN

Graphite Nickel

Special

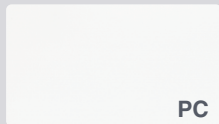

PC

Powdercoat

> Colours are from the Dulux range

To view this handle style in each finish option, visit our [website](#) and enter any product code listed on page 1 of this document.

Care & Maintenance

Stocked Finishes

To protect your handles we suggest cleaning the surface of your hardware periodically with a warm soapy lightly dampened cloth to remove any build-up of dust and grime that may cause corrosion and affect the integrity of the finish. Then simply dry thoroughly with a clean, soft cloth. Minimum of monthly cleaning of door handles is recommended for both finish preservation and general hygiene.

Atmospheric conditions, salt deposits, acids, caustic agents, cement or dust on construction sites all have the potential to cause discolouration to the surface.

Please avoid using any metal polishes, abrasive cleaners, scorers or rough cloths that may damage or scratch the hardware and do not spray or immerse the hardware in liquid to clean.