

# YORK

Discover timeless elegance with our traditional door handles, meticulously forged from premium solid brass.

Enhance your home decor effortlessly, adding a touch of sophistication and character to your doors.

## Rose

- 3009..... Lever Set
- 3021..... Passage Set
- 3022..... Privacy Set

### > Lever Set

Includes Levers only

### > Passage Set

Includes Levers and 1131 Tubular Latch – 60mm b/s

### > Privacy Set

Includes Levers, 8188 Turn and Escape\*, 1131 Tubular Latch and 1253 Privacy Bolt – 60mm b/s

\*8188 Turn and Escape has a 50mmØ rose

# TRADITIONAL



## Dimensions

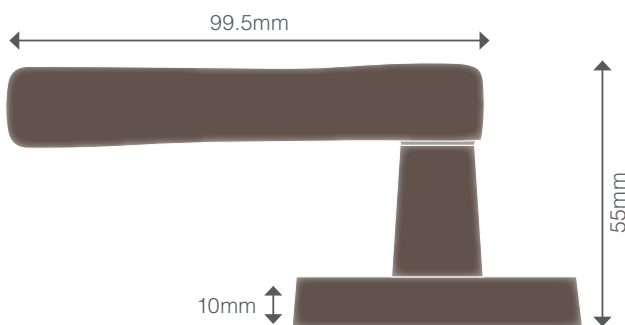
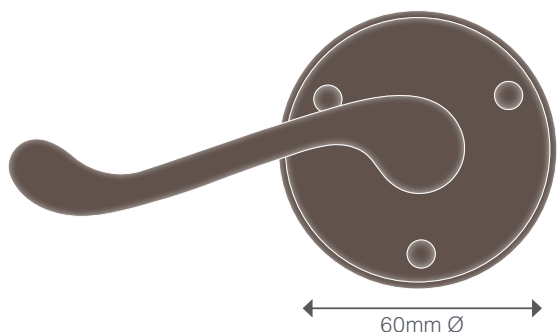

### Specs

- > Constructed from solid brass
- > Traditional exposed screws
- > 15 year mechanical warranty
- > Compatible with most existing mortice locks when retrofitting
- > 7.6mm x 100mm spindle
- > 6x 6g wood screws

### Installation

- > 70mm backset (see diagram)
- > 25mm drillout
- > Passage Set installation shown

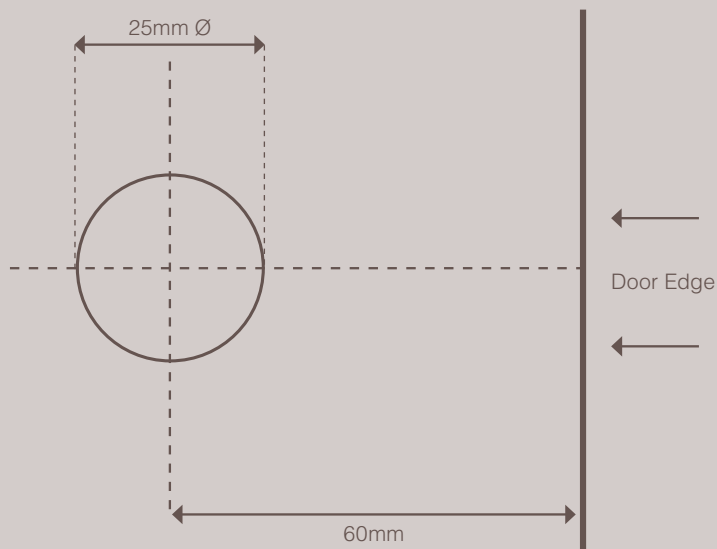
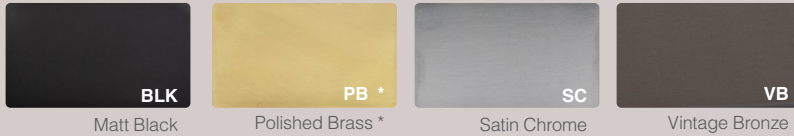

Diagram is not to scale, please refer to fitting instructions [here](#).

## Finishes

### Stocked



### Living

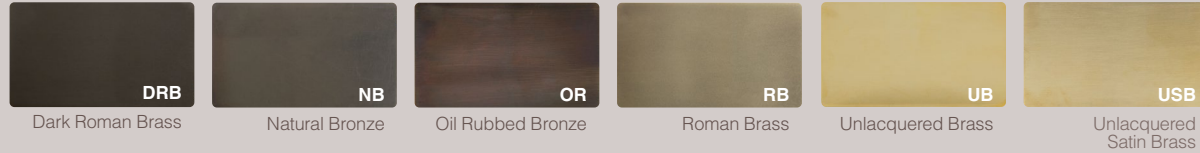

### Lacquered

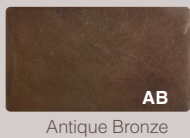

### Matt Lacquered

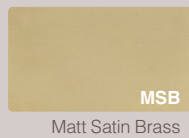

### Powdercoat

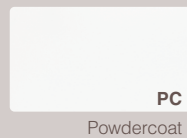

To view this handle style in each finish option, visit our [website](#) and enter any product code listed on page 1 of this document.

## Care & Maintenance

### Stocked Finishes

To protect your handles we suggest cleaning the surface of your hardware periodically with a warm soapy lightly dampened cloth to remove any build-up of dust and grime that may cause corrosion and affect the integrity of the finish. Then simply dry thoroughly with a clean, soft cloth. Minimum of monthly cleaning of door handles is recommended for both finish preservation and general hygiene.

Atmospheric conditions, salt deposits, acids, caustic agents, cement or dust on construction sites all have the potential to cause discolouration to the surface.

Please avoid using any metal polishes, abrasive cleaners, scorers or rough cloths that may damage or scratch the hardware and do not spray or immerse the hardware in liquid to clean.

\* We do not recommend using Polished Brass externally.

### Living Finishes

The living finishes will naturally patina over time with general use. As with all living and aging finishes, it is recommended to clean the surface periodically with a damp soapy cloth to remove any build up of dust and grime that may cause corrosion and affect the integrity of the finish.

Unlacquered Brass can be further protected by using the Windsor wax polish occasionally, rubbing this lightly over the surface will provide a layer of protection for extended finish longevity.

Oil Rubbed Bronze, Roman Brass and Dark Roman Brass can be preserved by gently applying a thin oil layer to the surface from time to time. Wipe a thin layer of olive oil (or similar) over the handle then with a clean cloth wipe again to remove any excess on the surface.

### Lacquered Finishes

The finishes with a lacquer are recommended to be kept free of dust and grime to prevent any chance of these particles affecting the integrity of the lacquer and potentially causing breakdown or discolouration. We suggest these are wiped and cleaned periodically using a mild window cleaner and damp cloth.

Gloss Lacquered finishes may get some light surface scratches appearing with normal wear and tear, for this we recommend using the Windsor wax polish occasionally, rubbing this lightly over the affected area to will provide a layer of protection for extended finish longevity.

We do not recommend Lacquered Finishes to be used externally as if badly scratched or damaged tarnishing can occur.