

HARDWARE COLLECTION



CONTENTS

04	40 Years	54	Cabinet Handles
06	Bespoke Hand Finishes	60	Accessories
08	Custom Process	68	Window Hardware
10	Entrance Hardware	74	Windsor Finishes
20	Italian	76	Technical Information
34	NIDO	78	Support
48	Galaxy	80	Project Highlight



40 YEARS

Peter Hickmott, a fitter and turner by trade, needed a pull handle for his front door, but couldn't find exactly what he had envisioned, so decided to engineer his own.

He approached Smith City Market for feedback and they commended his efforts, but their real need was brass cabinet knobs. Peter agreed to meet their request and the first Windsor Brass order was placed.

1980s

During late nights and early mornings, Peter tirelessly crafted the cabinet knobs in a backyard garage utilising a friend's lathe. Expanding to D cabinet handles, he then began to secure joiner customers in Christchurch and Auckland.

By 1986, a pivotal order led him to resign from his day job at CWF Hamilton's, fully committing to Windsor Brass.

After extensive research and experimentation in 20L buckets we created our first special finish, Antique Bronze.

Two years later he transitioned from the home garage to our inaugural industrial premises, hired our first employee and launched our first range.

1990s

Windsor began importing superior brass enabling the ability to offer a full suite of architectural hardware.

Faced with increasing demand, in 1991 Windsor moved to a larger premises employing further staff and established a sales team.

Two years later Peter and Rose Hickmott relocated the business to Invercargill.

2000s

2003 was a pivotal moment where we introduced our first volume builder and Brushed Nickel range, Astron. This expedited significant growth by entering a new market, continuing to expand our range and customer base, resulting in our third rebrand.

2010s

With a workforce of 20 employees geared for expansion, we moved into our current purpose-built facility.

Our finish offering grew including our signature hand finishes, but this decade also saw the introduction of the popular Matt Black and Graphite Nickel finishes.

The brand evolved from Windsor Brass to Windsor Architectural Hardware incorporating our extensive product range and market offering.

2020s

Our team structure underwent a significant change bringing new expertise in-house including global sales, marketing, IT, HR and accounting.

This laid the foundations to expand to Australia and in 2022 we employed our first Australian sales rep.

Exceptional customer service and quality products has always been at the core of what we do, and we'd like to thank our loyal customers for trusting in Windsor for the past 40 years!

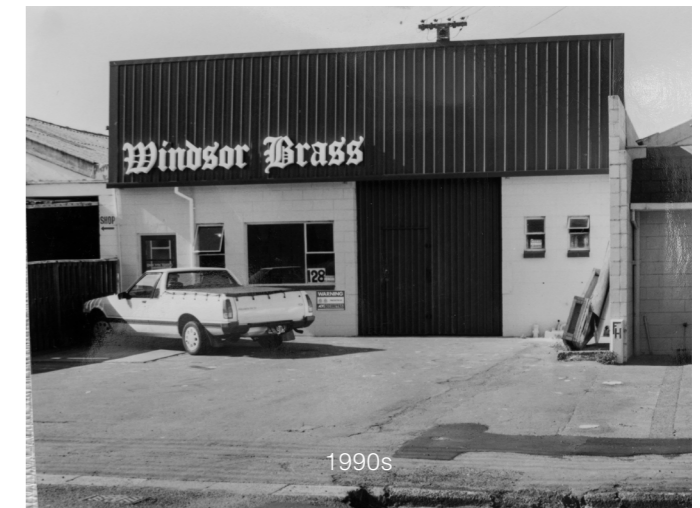



DISASSEMBLED WINDOW HARDWARE
BEING PROCESSED INTO DARK ROMAN BRASS

BESPOKE HAND FINISHES

Our signature collection of bespoke hand finishes has been honed over four decades of perfecting its true artisan form.

They've always been a labour of love which began with dipping cabinet knobs in 20 litre buckets in the backyard to apply a lacquer and curing them in the family living room. Over time processes were refined, trends evolved and our collection grew.

Our hardware is forged and machined using the finest quality solid brass arriving at Windsor in a natural, raw state—a blank canvas ready to take on a new look.

To create the different finishes, we use a variety of metal treatments, then the finish is relieved-back by hand by our team of specialist craftspeople.

Some finishes are left in their natural state to age gracefully over time, these are our living finishes, others are coated with a resin lacquer to protect the colour and provide either a high gloss or matt finish, these are our lacquered finishes.

Door accessories, window hardware and pull handles are batch processed for precise colour coordination.

From our hands, to yours.



HALF MOON PULL HANDLES FROM SOLID BRASS
IN A BESPOKE BRASS FINISH TO MATCH CLIENT TAPWARE

CUSTOM PROCESS

Consultation

Contact us to schedule a consultation where we can discuss your unique requirements for custom door handles.

Design Proposal Review

Once we've collaborated on the design, you'll have the opportunity to review and approve the proposed design before we proceed.

Material and Finish Selection

Choose from our range of materials and finishes to ensure your custom door handles perfectly match your aesthetic preferences.

Quotation and Approvals

After finalising the design, you'll receive a detailed quote outlining the costs, and upon acceptance, we'll proceed with payment arrangements.

Production

Our skilled craftsmen will then meticulously craft your door handles according to the approved design and specifications.

Quality Assurance Check

Each handle undergoes a thorough inspection process to ensure it meets our standards of quality and craftsmanship.

Delivery

Once completed, your custom door handles will be carefully packaged and promptly shipped to your specified location.

Installation Instructions

Upon arrival, follow our detailed instructions to ensure a smooth and hassle-free installation process.

ENTRANCE HARDWARE

First impressions are just as important when it comes to your front door—make a statement with your entrance hardware and set the scene of luxury as it weaves through the rest of your home.

This collection of pull handles is constructed from solid brass and hand finished.

ENTRANCE HARDWARE



MILFORD 400MM
IN DARK ROMAN BRASS

ENTRANCE

Milford

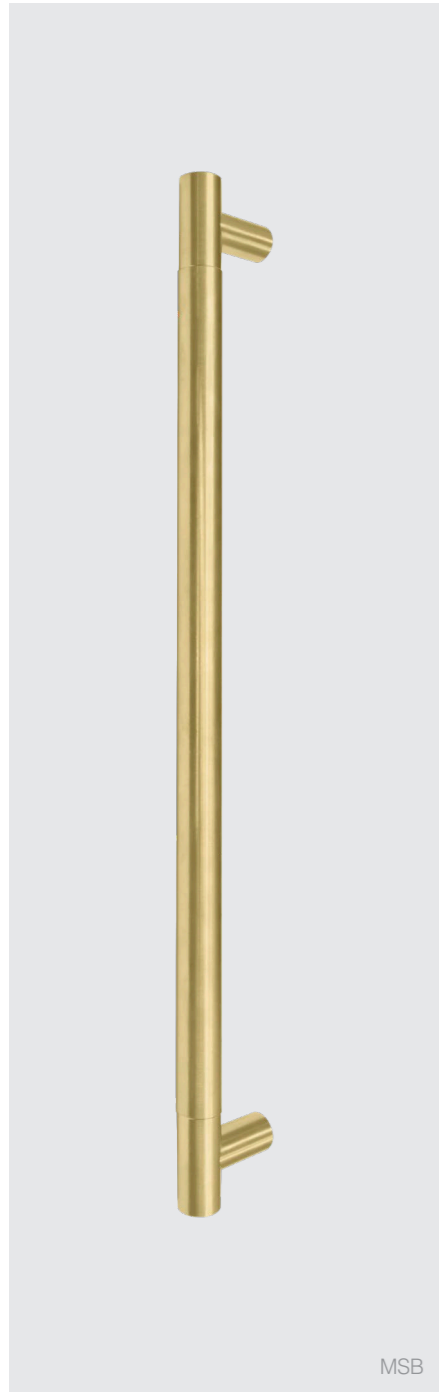

MSB

code	mm o/a	mm crs	mm bar	mm pj
8331	400	340	25	65
8332	600	540	25	65

Finishes:



Kepler

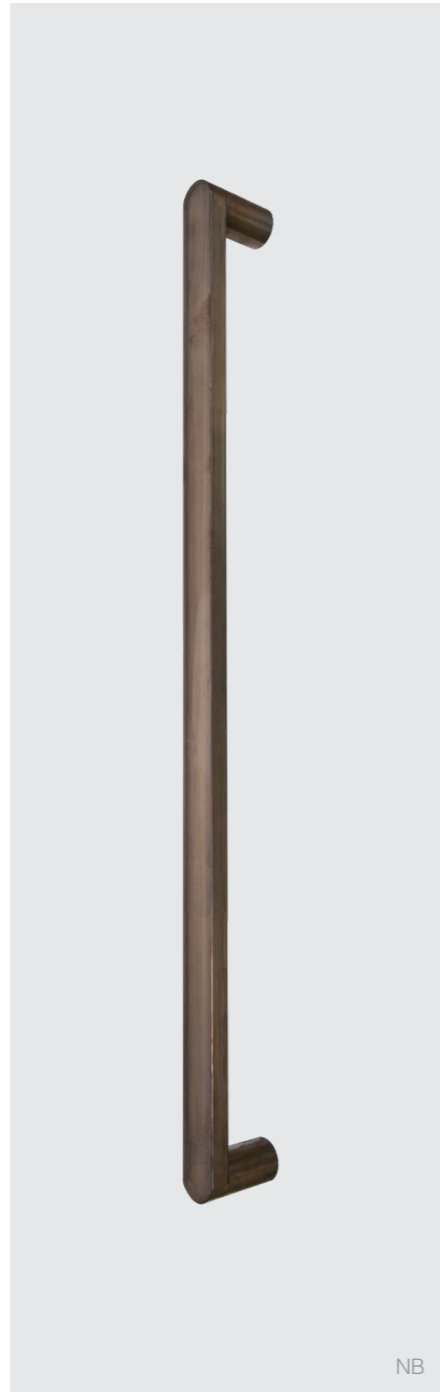

NB

code	mm o/a	mm crs	mm bar	mm pj
8336	400	375	25 x 12	53
8337	600	575	25 x 12	53

Tasman

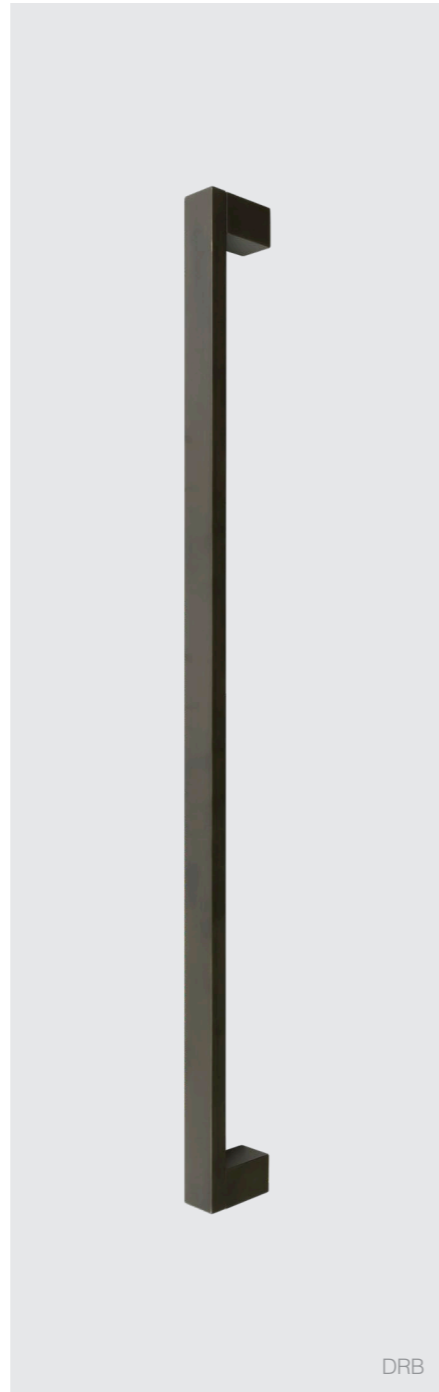

DRB

code	mm o/a	mm crs	mm bar	mm pj
8341	400	375	25 x 12	53
8342	600	575	25 x 12	53

Round Profile – Plain



MSB

code	mm o/a	mm crs	mm bar	mm pj
8355	450	390	19	52
8358	600	540	19	52
8361	900	840	19	52

Finishes:



Round Profile – Diamond Knurled



DRB

code	mm o/a	mm crs	mm bar	mm pj
8353	450	390	19	52
8356	600	540	19	52
8359	900	840	19	52

Round Profile – Linear Knurled



RB

code	mm o/a	mm crs	mm bar	mm pj
8354	450	390	19	52
8357	600	540	19	52
8360	900	840	19	52

Round Profile



USB

code	mm o/a	mm crs	mm bar	mm pj
8190	300	210	19	52
8191	400	300	19	52

Finishes:



Square Profile



RB

code	mm o/a	mm crs	mm bar	mm pj
8192	300	210	17 x 17	53



OR

code	mm o/a	mm crs	mm bar	mm pj
8193	235	210	25 x 25	42

These styles can also be custom made to any length up to 800mm for all finishes. For lengths above 800mm please enquire for available finish options and lead times.

Recommend pairing with Double Turn Lock Kits on page 14.

ENTRANCE

Euro 85 Lock

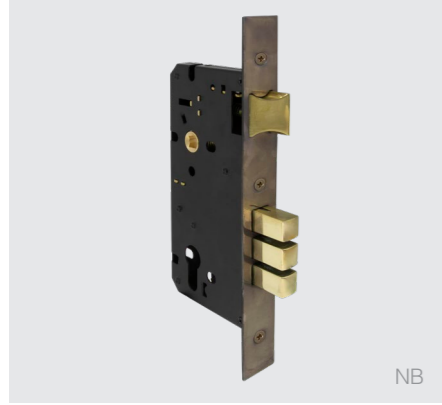

NB

1402 45mm b/s
71mm c/s

1403 60mm b/s
86mm c/s

Finishes:

Available in all special finishes refer to page 75



BLK

1142 45mm b/s
71mm c/s
Not available in GN

1143 60mm b/s
86mm c/s

Finishes:

BLK GN SS PC

Euro 48 Lock



USB

1114 45mm b/s
66mm c/s

1115 57mm b/s
78mm c/s

1169 Rebated Lock Kit

1170 Lock Kit

Finishes:

BLK BN SS

Available in all special finishes refer to page 75

5 Pin Euro Double Cylinder



MSB

1121 60mm
1147 70mm

Finishes:

BLK BN GN SC

Available in all special finishes refer to page 75



OR

1222 80mm

Finishes:

Available in all special finishes refer to page 75

5 pin Euro Single Cylinder Key



USB

1133 30mm
1199 35mm

Finishes:

BLK BN SC

Available in all special finishes refer to page 75

Deadbolt



PB

1130 45mm b/s,
66mm c/s

1135 57mm b/s
78mm c/s

Finishes:

Available in all special finishes refer to page 75

Heavy Duty Roller Lock



RB

1139 45mm b/s
65mm c/s

1140 57mm b/s
76mm c/s

Finishes:

Available in all special finishes refer to page 75

Heavy Duty Roller Catch



SS

1195 67mm b/s
62mm c/s

Finishes:

SS PC

5 Pin Euro Cylinder Turn



AB

1223 80mm

Finishes:

BN SC

Available in all special finishes refer to page 75

5 Pin Euro Single Cylinder Turn



DRB

1122 60mm
1148 70mm

Finishes:

BLK BN GN SC

Available in all special finishes refer to page 75

5 Pin Euro Single Cylinder Turn



RB

1134 30mm
1200 35mm

Finishes:

BLK BN SC

Available in all special finishes refer to page 75

Roller Lock Kit



BN

1138
57mm Heavy Duty Case
60mm b/s

Finishes:

Available in all special finishes refer to page 75

Double Turn Lock Kit



MSB

1550 Plain
1551 Diamond Knurled
1552 Linear Knurled

57mm b/s bolt
56mm Ø x 7mm roses

Finishes:

BLK BN GN MSB DRB RB



GN

1183 54mm Ø roses
60mm b/s

Finishes:

BLK BN GN SC

Available in all special finishes refer to page 75

Escutcheons

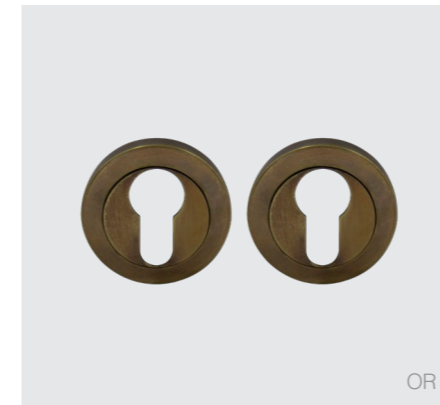

OR

8189 Euro Pair
50mm Ø x 8mm

Finishes:

BN SC

Available in all special finishes refer to page 75



MSB

8420 Euro Pair
56mm Ø x 7mm

Finishes:

BLK BN GN MSB DRB RB

Available in all special finishes refer to page 75



BN

9035 Euro Pair
54mm Ø x 10mm

Finishes:

BLK BN GN SC PC

Available in all special finishes refer to page 75

ENTRANCE

Round Profile - Plain, Diamond, Linear Knurled

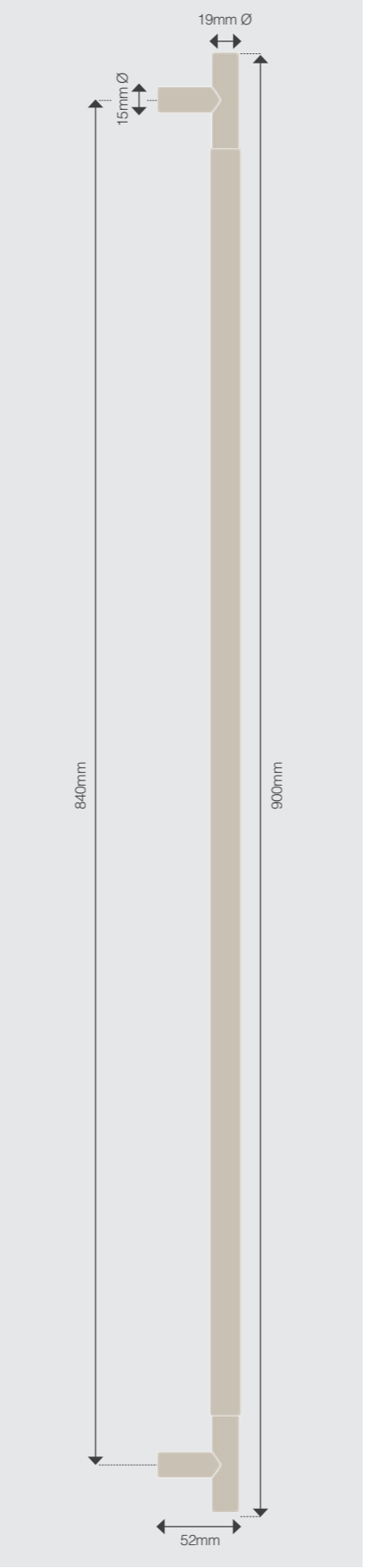
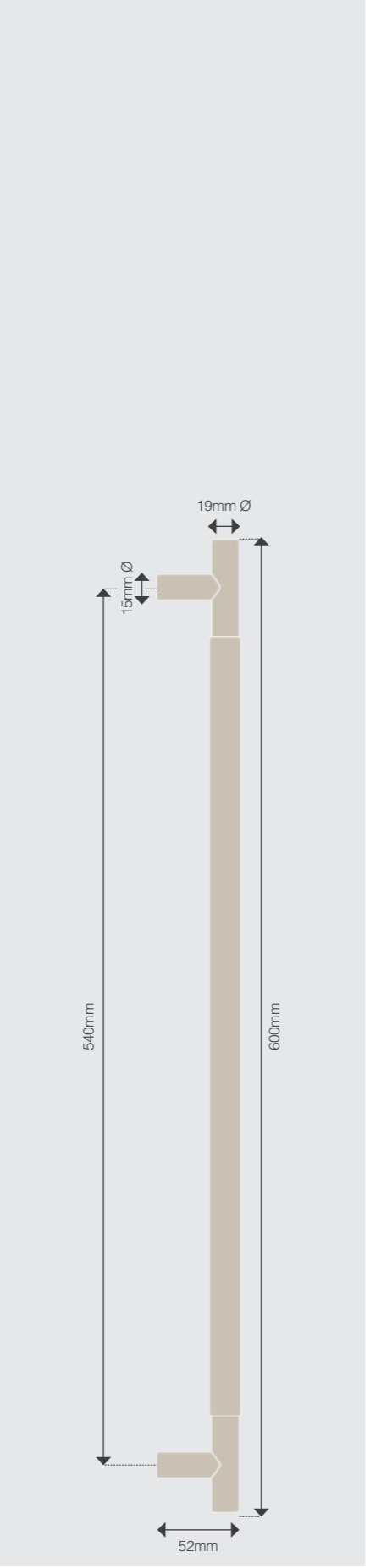
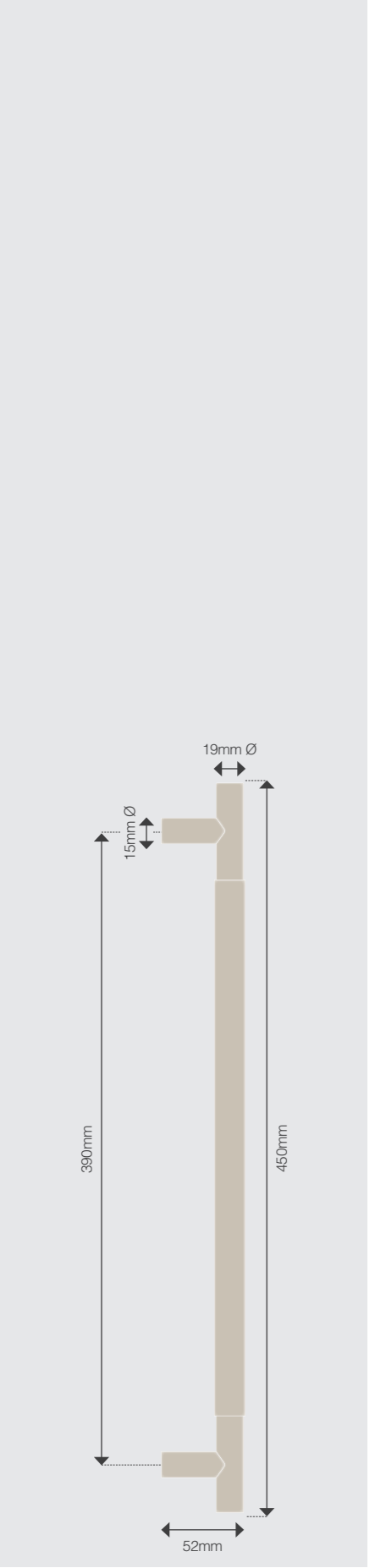

Product Dimensions

Milford

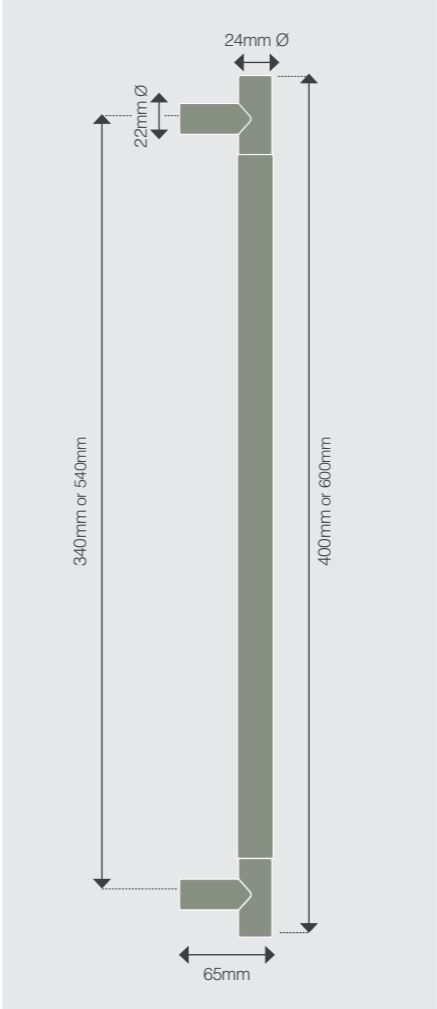

Kepler

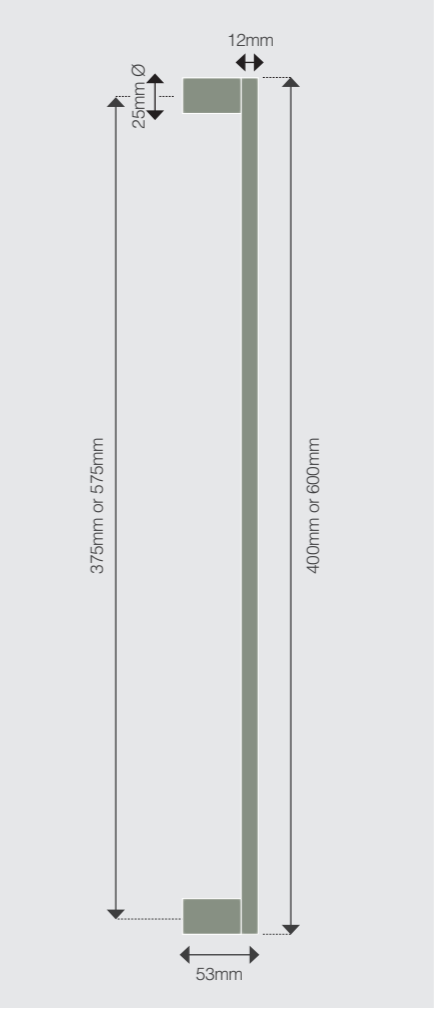

Tasman

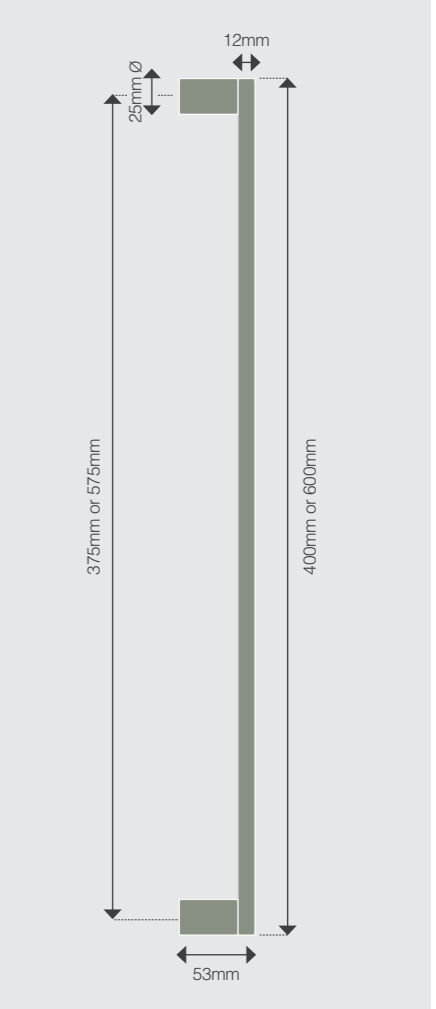

Round Profile

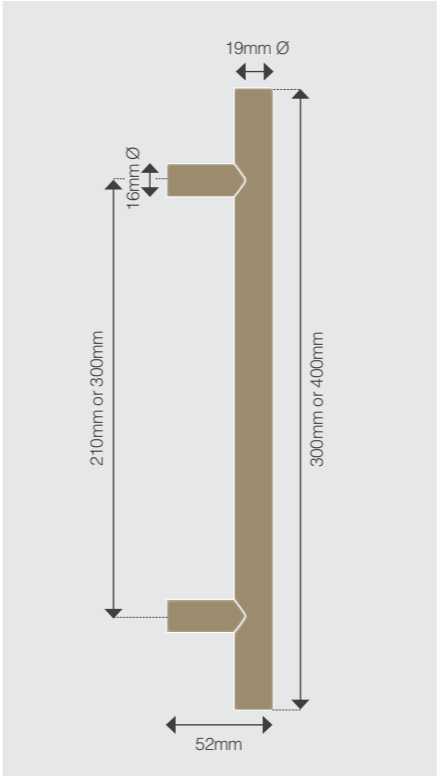

Square Profile

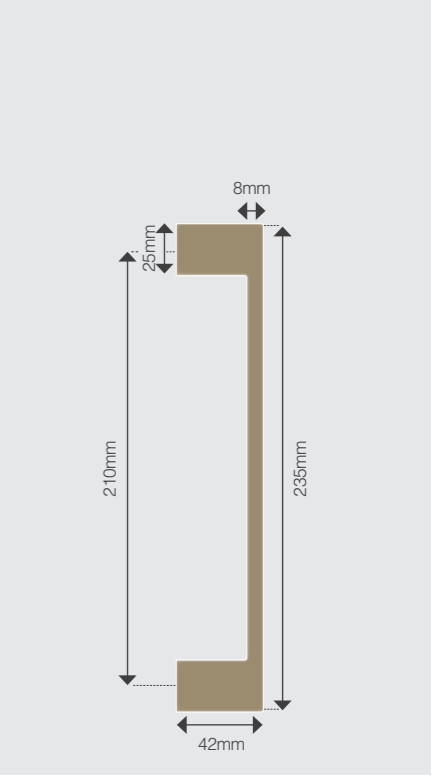
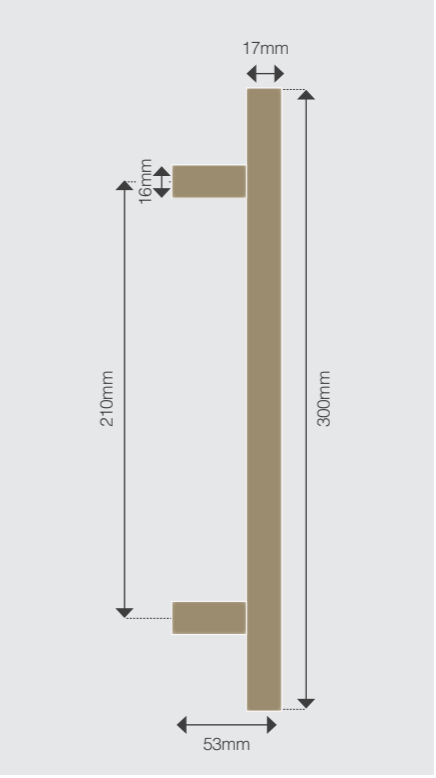



1200MM CUSTOM SOLID BRASS PULL HANDLE
IN UNLACQUERED SATIN BRASS

ITALIAN

Everyone has their own curated collection of life's little luxuries. The taste of a fine wine, scent of your favourite perfume or feel of Egyptian cotton sheets.

Let the distinct touch of solid brass door handles become one of them.

Make every door you open a little more special.

This range is forged and machined in the Italian Alps using the finest quality solid brass, it arrives at Windsor in a raw state for final machining, hand finishing and assembly.

ITALIAN



VILLA LEVER ON TRADITIONAL LONGPLATE
IN POLISHED BRASS

CHARLESTON



Small Rose - OR



Large Rose - BN



Square Longplate - USB

Small Rose

52mm Ø rose

- 8201 Lever Set
- 8201D Dummy Lever
- 8202 Passage Set
- 8207 Privacy Set - Separate
- 8209 E85 Entrance Set

Large Rose

64mm Ø rose

- 8206 Lever Set
- > Large rose option ideal for retro-fit
- > Not compatible with mortice

Square Longplate

265mm x 42mm x 10mm plate

- | | |
|-------------------------|-----------------------|
| 8205 Blank | 8271 Passage Set |
| 8205LD Dummy Lever - LH | 8272 Privacy Set |
| 8205RD Dummy Lever - RH | 8273 E48 Entrance Set |
| 8205-E48 E48 Lever Set | 8274 E85 Entrance Set |
| 8205-E85 E85 Lever Set | |

Finishes:



> Magnetic latches available for use with passage and privacy sets.

CHALET



Small Rose - AB



Large Rose - RLB



Square Longplate - RB

Small Rose

52mm Ø rose

- 8211 Lever Set
- 8211D Dummy Lever
- 8212 Passage Set
- 8217 Privacy Set - Separate
- 8219 E85 Entrance Set

Large Rose

64mm Ø rose

- 8216 Lever Set
- > Large rose option ideal for retro-fit
- > Not compatible with mortice

Square Longplate

265mm x 42mm x 10mm plate

- | | |
|-------------------------|-----------------------|
| 8215 Blank | 8297 Passage Set |
| 8215LD Dummy Lever - LH | 8298 Privacy Set |
| 8215RD Dummy Lever - RH | 8299 E48 Entrance Set |
| 8215-E48 E48 Lever Set | 8300 E85 Entrance Set |
| 8215-E85 E85 Lever Set | |

Finishes:



> Magnetic latches available for use with passage and privacy sets.

FEDERAL



Small Rose - AB



Large Rose - MSB

Small Rose
52mm Ø rose

8221 Lever Set
8221D Dummy Lever
8222 Passage Set
8227 Privacy Set - Separate
8229 E85 Entrance Set

Large Rose
64mm Ø rose

8226 Lever Set
> Large rose option ideal for retro-fit
> Not compatible with mortice

Finishes:



Square Longplate - DRB

Square Longplate
265mm x 42mm x 10mm plate

8225 Blank
8225LD Dummy Lever - LH
8225RD Dummy Lever - RH
8225-E48 E48 Lever Set
8225-E85 E85 Lever Set

8275 Passage Set
8276 Privacy Set
8277 E48 Entrance Set
8288 E85 Entrance Set

Finishes:

VILLA



Small Rose - SC



Large Rose - NB

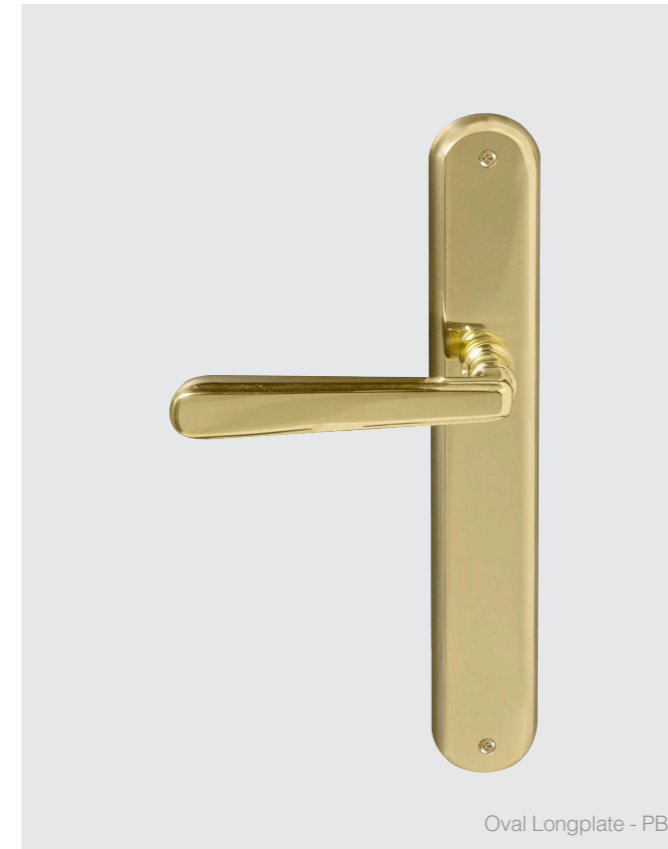

Oval Longplate - PB

Small Rose
52mm Ø rose

8231 Lever Set
8231D Dummy Lever
8232 Passage Set
8237 Privacy Set - Separate
8239 E85 Entrance Set

Large Rose
64mm Ø rose

8236 Lever Set
> Large rose option ideal for retro-fit
> Not compatible with mortice

Finishes:



Traditional Longplate - OR

Oval Longplate
255mm x 42mm x 10mm plate

8233 Blank
8233LD Dummy Lever - LH
8233RD Dummy Lever - RH
8233-E48 E48 Lever Set
8233-E85 E85 Lever Set
8289 Passage Set
8290 Privacy Set
8291 E48 Entrance Set
8292 E85 Entrance Set

Traditional Longplate
255mm x 50mm x 10mm plate

8234 Blank
8234LD Dummy Lever - LH
8234RD Dummy Lever - RH
8234-E48 E48 Lever Set
8234-E85 E85 Lever Set
8293 Passage Set
8294 Privacy Set
8295 E48 Entrance Set
8296 E85 Entrance Set

Finishes:

HAVEN



Small Rose - RB



Large Rose - RLB

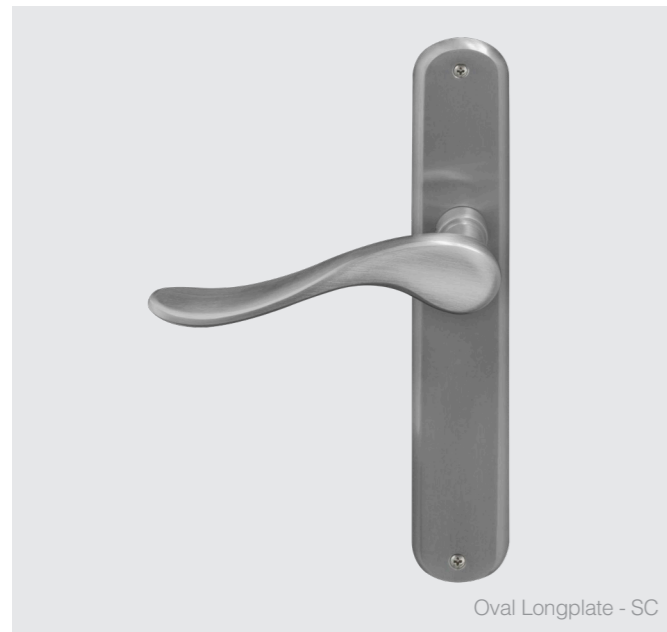

Oval Longplate - SC



Square Longplate - DRB



Traditional Longplate - NB

Small Rose
52mm Ø rose

8167	Lever Set
8167LD	Dummy Lever - LH
8167RD	Dummy Lever - RH
8240	Passage Set
8241	Privacy Set - Separate
8243	E85 Entrance Set

Large Rose
64mm Ø rose

8196 Lever Set

Square Longplate
265mm x 42mm x 10mm plate

8194	Blank
8194LD	Dummy Lever - LH
8194RD	Dummy Lever - RH
8194-E48	E48 Lever Set
8194-E85	E85 Lever Set
8244	Passage Set
8245	Privacy Set
8246	E48 Entrance Set
8247	E85 Entrance Set

Oval Longplate
255mm x 42mm x 10mm plate

8168	Blank
8168LD	Dummy Lever - LH
8168RD	Dummy Lever - RH
8168-E48	E48 Lever Set
8168-E85	E85 Lever Set
8248	Passage Set
8249	Privacy Set
8250	E48 Entrance Set
8251	E85 Entrance Set

Traditional Longplate
255mm x 50mm x 10mm plate

8169	Blank
8169LD	Dummy Lever - LH
8169RD	Dummy Lever - RH
8169-E48	E48 Lever Set
8169-E85	E85 Lever Set
8252	Passage Set
8253	Privacy Set
8254	E48 Entrance Set
8255	E85 Entrance Set

Finishes:

BN
 SC
 AB
 DRB
 MSB
 NB
 OR
 PB
 PC
 RB
 UB
 USB

Finishes:

BN
 SC
 AB
 DRB
 MSB
 NB
 OR
 PB
 PC
 RB
 UB
 USB

> Large rose option ideal for retro-fit
> Not compatible with mortice

> Magnetic latches available for use with passage and privacy sets.

Accessories

Turn & Escape on Rose

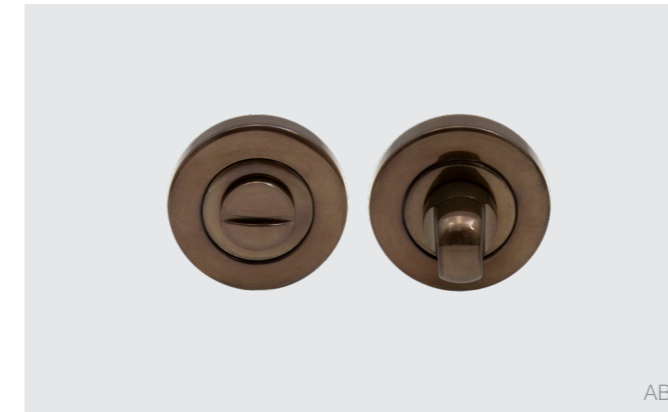

AB

8188 50mm Ø x 9mm roses

Finishes:

BN
 SC
 Available in all special finishes refer to page 75

Double Turn Set



OR

8118 50mm Ø 9mm roses

Finishes:

BN
 SC
 Available in all special finishes refer to page 75

Privacy Set

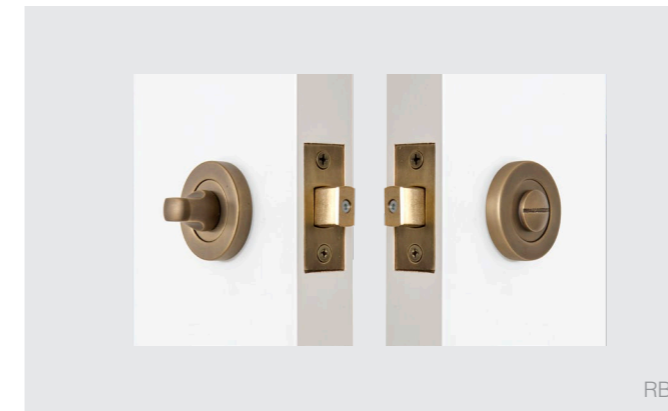

RB

8087 50mm Ø x 9mm roses
57mm b/s

Finishes:

BN
 SC
 Available in all special finishes refer to page 75



ITALIAN

Charleston

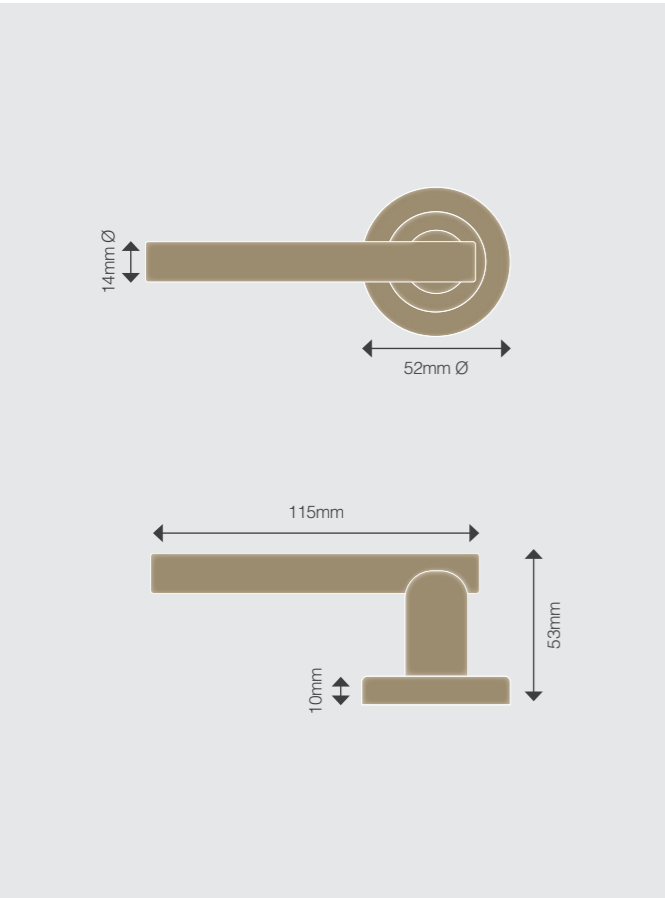

Chalet

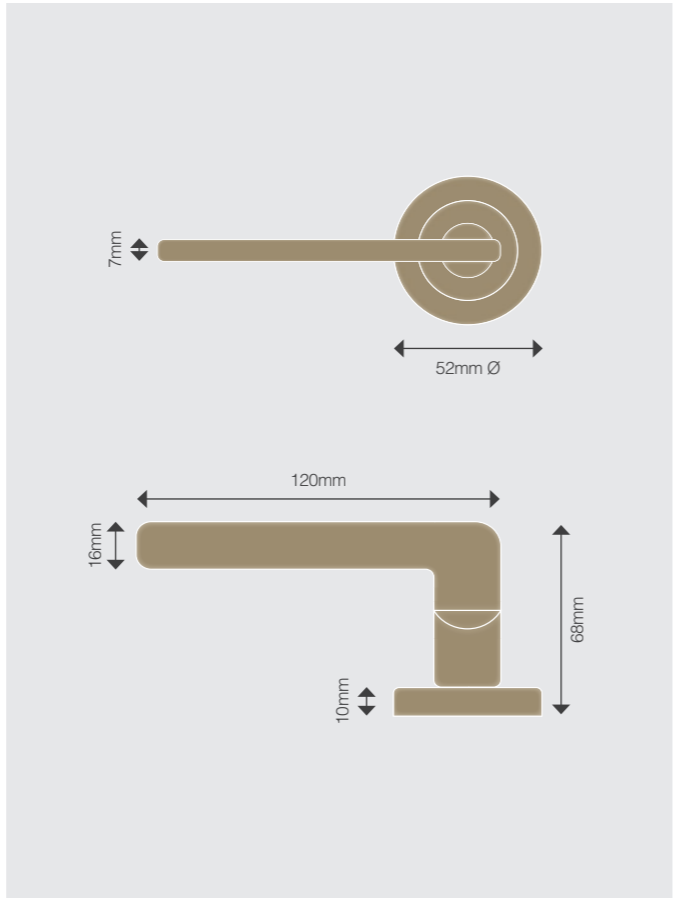

Federal

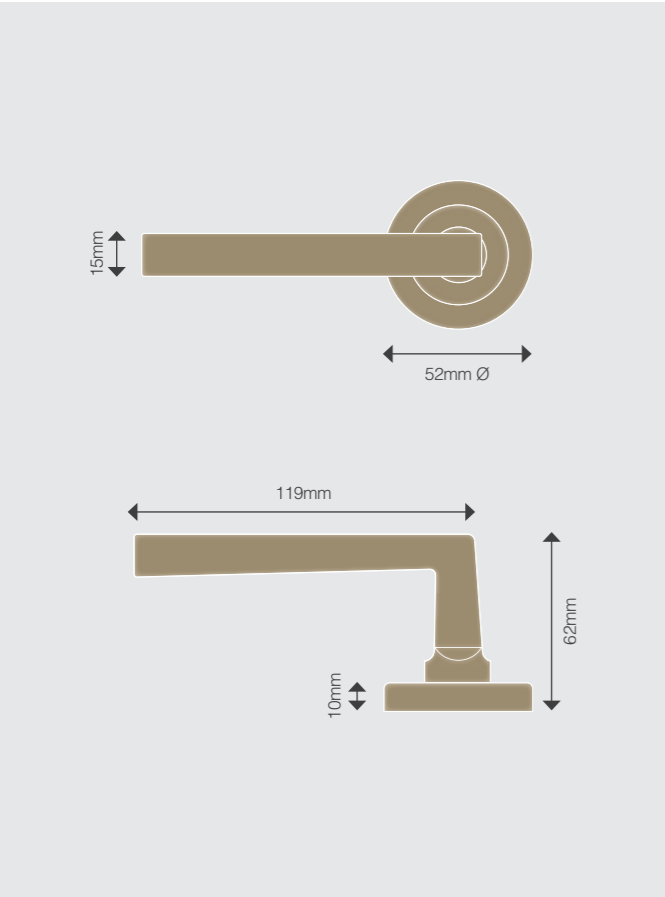

Villa

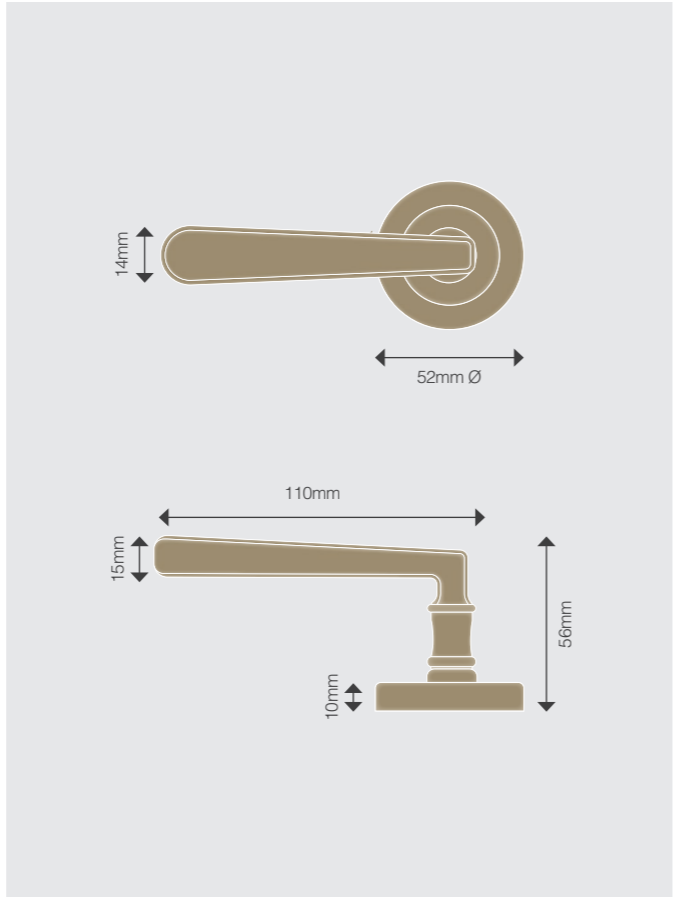

Product Dimensions

Haven

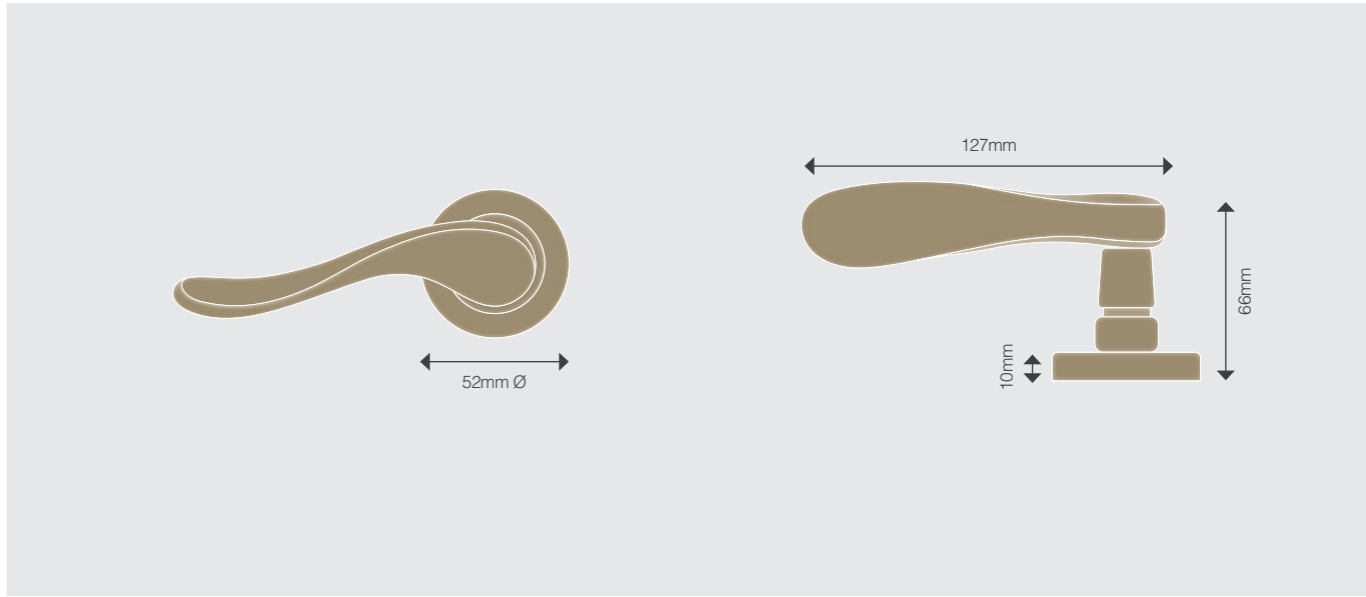

Backing Options*

Roses
10mm deep
Longplates
10mm deep

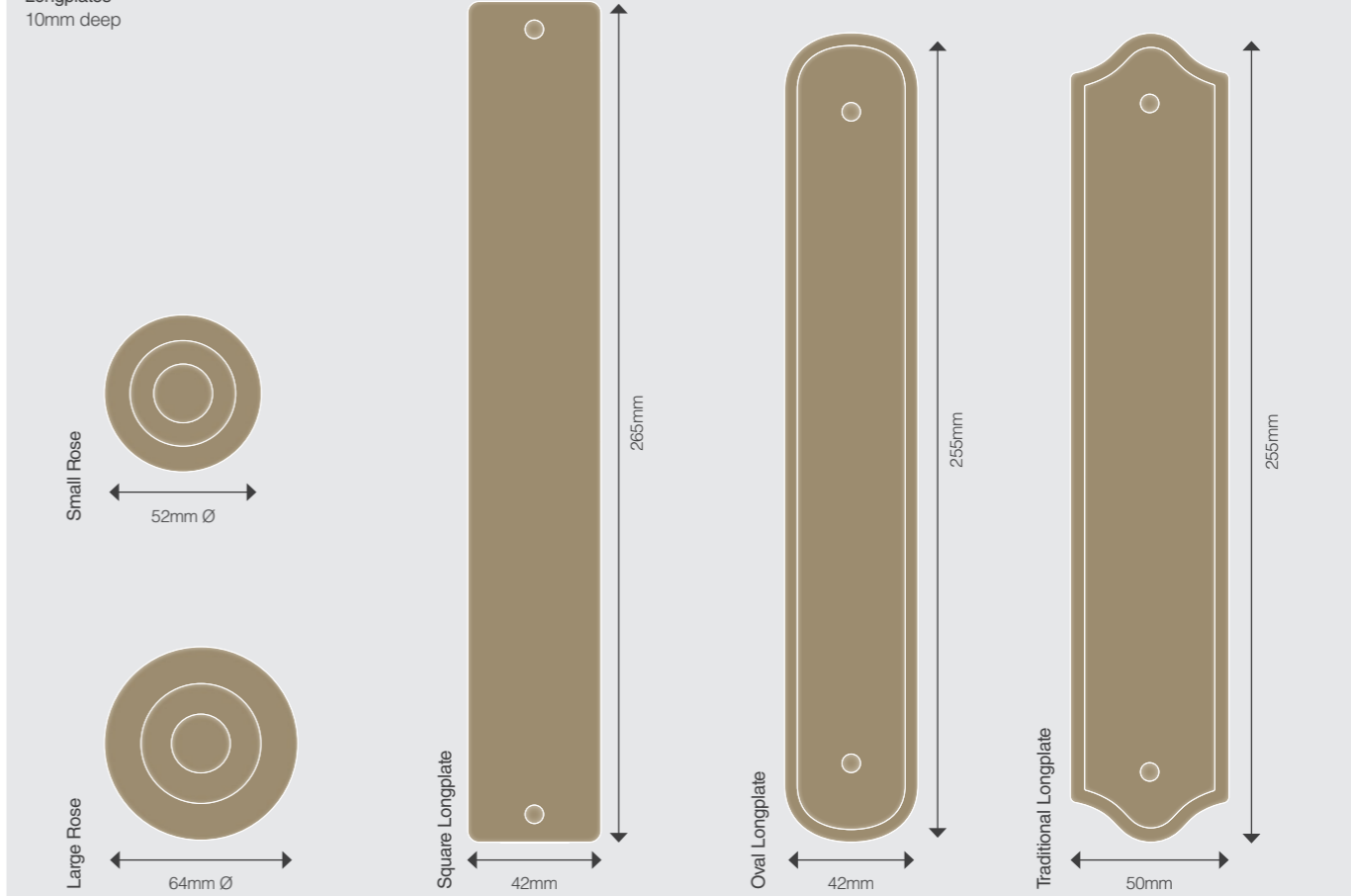

* Backing Options
Charleston, Chalet and Federal available in Square Longplate.
Villa available in Oval and Traditional Longplates.
Haven available in Square, Oval and Traditional Longplates.



CHALET LEVER
IN RUMBLED BRASS

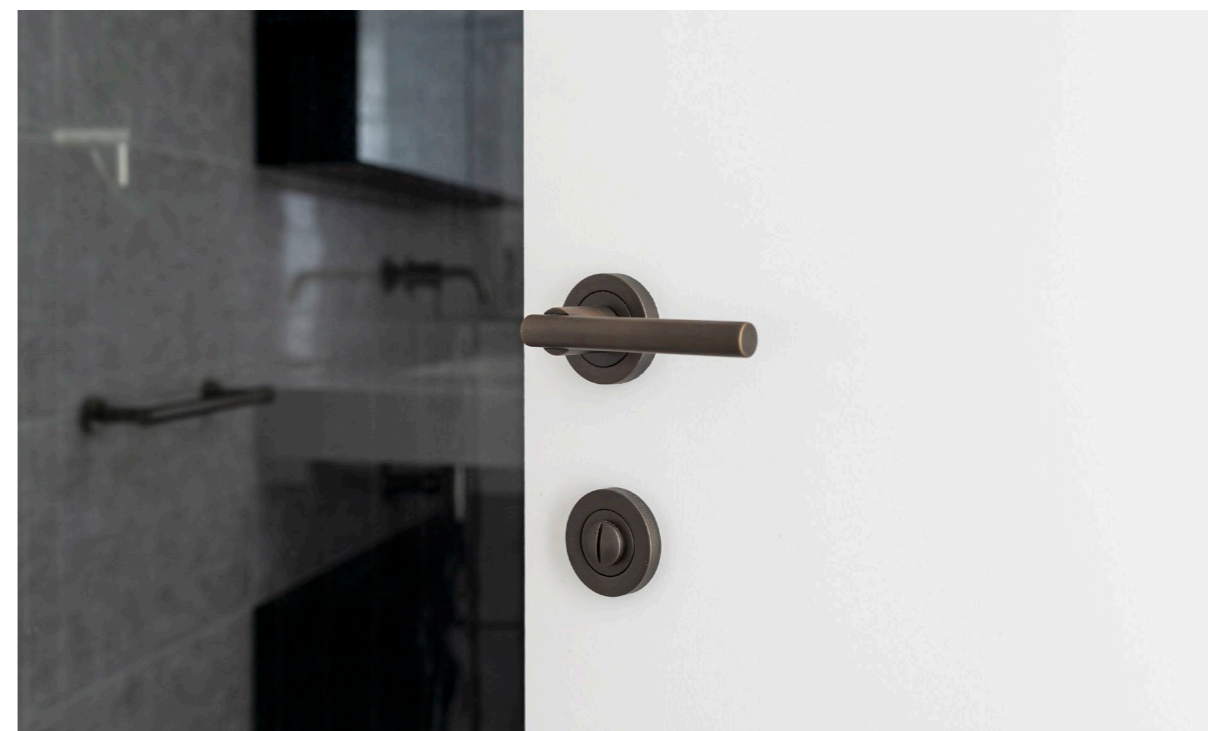

CHARLESTON LEVER
IN DARK ROMAN BRASS

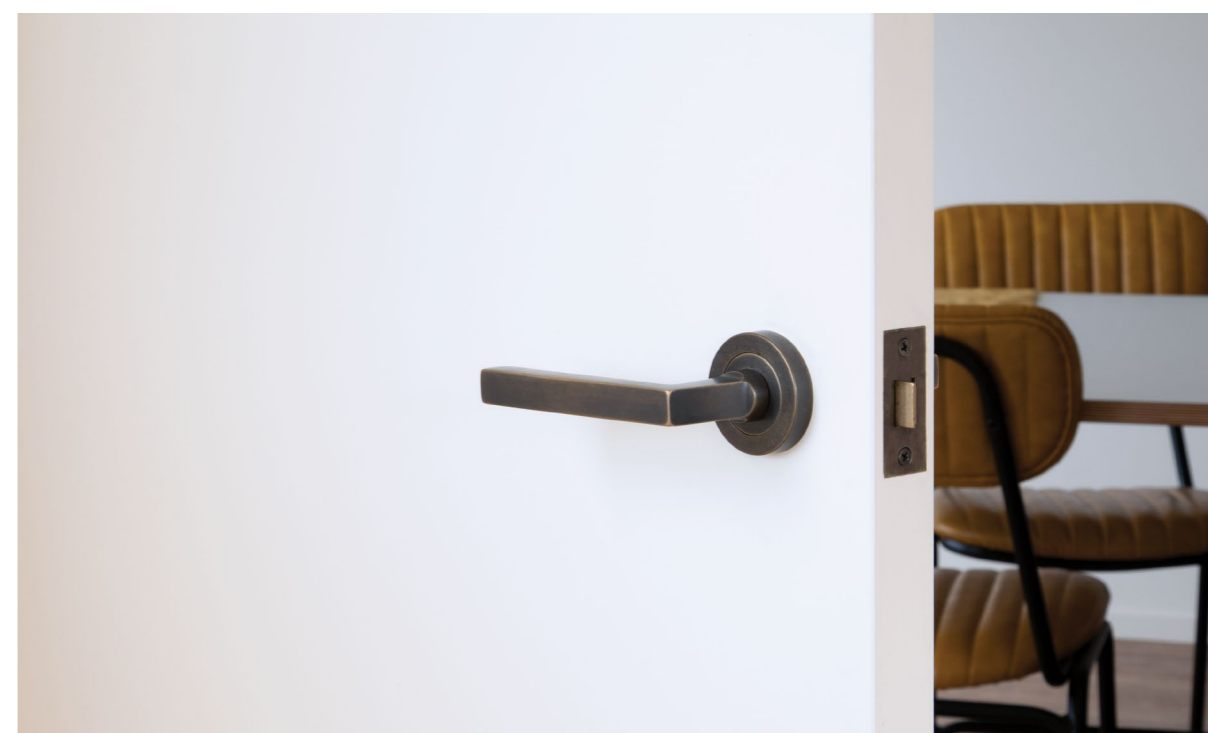

FEDERAL LEVER
IN OIL RUBBED BRONZE

NIDO

Sleek edges embellished with raw texture offer a sensory experience.

Simplicity and complexity unite in a harmonious fusion.

A natural evolution of industrial elegance.

This range uses a combination of cast and machined parts from high grade solid brass, crafted to detailed perfection.

NIDO



VERGE - DIAMOND KNURLED LEVER ON LONGPLATE
IN GRAPHITE NICKEL

VERGE

Plain



Diamond Knurled

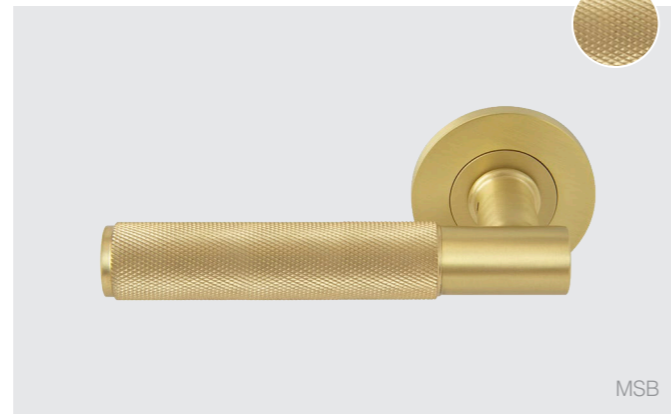

Linear Knurled



- | | |
|---------------------------------|--|
| Rose
56mmØ x 7mm rose | Longplate
230mm x 40mm x 6mm plate |
| 8421 Lever Set | 8423 Lever Set |
| 8421D Dummy Lever | 8423LD Dummy Lever - LH |
| 8422 Passage Set | 8423RD Dummy Lever - RH |
| 8425 Privacy Set – Separate | 8423-E85 E85 Lever Set |
| 8424 Entrance Set | 8427 Passage Set |
| | 8428 Privacy Set |
| | 8426 E85 Entrance Set |



- | | |
|---------------------------------|--|
| Rose
56mmØ x 7mm rose | Longplate
230mm x 40mm x 6mm plate |
| 8431 Lever Set | 8433 Lever Set |
| 8431D Dummy Lever | 8433LD Dummy Lever - LH |
| 8432 Passage Set | 8433RD Dummy Lever - RH |
| 8435 Privacy Set – Separate | 8433-E85 E85 Lever Set |
| 8434 Entrance Set | 8437 Passage Set |
| | 8438 Privacy Set |
| | 8436 E85 Entrance Set |



- | | |
|---------------------------------|--|
| Rose
56mmØ x 7mm rose | Longplate
230mm x 40mm x 6mm plate |
| 8481 Lever Set | 8483 Lever Set |
| 8481D Dummy Lever | 8483LD Dummy Lever - LH |
| 8482 Passage Set | 8483RD Dummy Lever - RH |
| 8485 Privacy Set – Separate | 8483-E85 E85 Lever Set |
| 8484 Entrance Set | 8487 Passage Set |
| | 8488 Privacy Set |
| | 8486 E85 Entrance Set |



> Magnetic latches available for use with passage and privacy sets.

> Magnetic latches available for use with passage and privacy sets.

LUMINA

Plain



Diamond Knurled



Linear Knurled

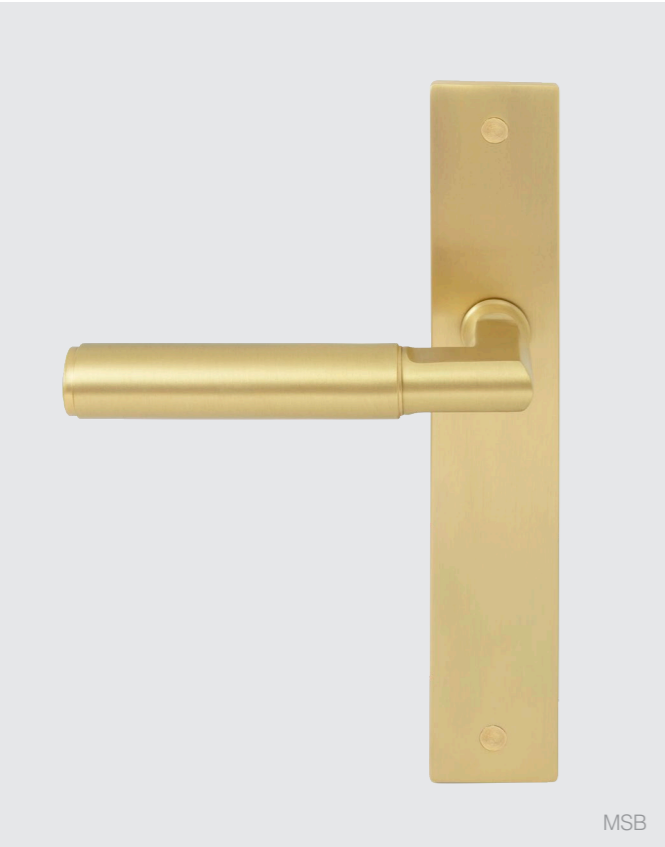

- | | |
|---------------------------------|--|
| Rose
56mmØ x 7mm rose | Longplate
230mm x 40mm x 6mm plate |
| 8401 Lever Set | 8403 Lever Set |
| 8401D Dummy Lever | 8403LD Dummy Lever - LH |
| 8402 Passage Set | 8403RD Dummy Lever - RH |
| 8405 Privacy Set – Separate | 8403-E85 E85 Lever Set |
| 8404 Entrance Set | 8407 Passage Set |
| | 8408 Privacy Set |
| | 8406 E85 Entrance Set |

- | | |
|---------------------------------|--|
| Rose
56mmØ x 7mm rose | Longplate
230mm x 40mm x 6mm plate |
| 8411 Lever Set | 8413 Lever Set |
| 8411D Dummy Lever | 8413LD Dummy Lever - LH |
| 8212 Passage Set | 8413RD Dummy Lever - RH |
| 8415 Privacy Set – Separate | 8413-E85 E85 Lever Set |
| 8414 Entrance Set | 8417 Passage Set |
| | 8418 Privacy Set |
| | 8416 E85 Entrance Set |

- | | |
|---------------------------------|--|
| Rose
56mmØ x 7mm rose | Longplate
230mm x 40mm x 6mm plate |
| 8491 Lever Set | 8493 Lever Set |
| 8491D Dummy Lever | 8493LD Dummy Lever - LH |
| 8492 Passage Set | 8493RD Dummy Lever - RH |
| 8495 Privacy Set – Separate | 8493-E85 E85 Lever Set |
| 8494 Entrance Set | 8497 Passage Set |
| | 8498 Privacy Set |
| | 8496 E85 Entrance Set |



> Magnetic latches available for use with passage and privacy sets.

> Magnetic latches available for use with passage and privacy sets.

MODELLA

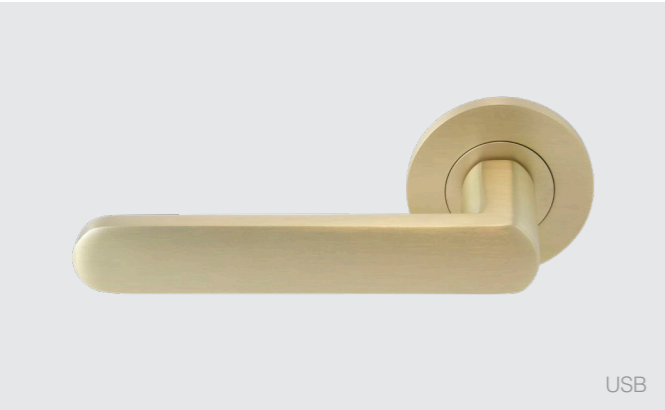

Rose
56mmØ x 7mm rose
8441 Lever Set
8441D Dummy Lever
8442 Passage Set
8445 Privacy Set - Separate
8444 Entrance Set

Longplate
230mm x 40mm x 6mm plate
8443 Lever Set
8443LD Dummy Lever - LH
8443RD Dummy Lever - RH
8443-E85 E85 Lever Set
8447 Passage Set
8448 Privacy Set
8446 E85 Entrance Set

Finishes:
 BLK BN CCB GN MSB DRB OR RB USB

Accessories

Turn & Escape on Rose



8408 Plain
8409 Diamond Knurled
8455 Linear Knurled
56mm Ø x 7mm roses

Finishes:
 BLK BN CCB GN MSB DRB OR RB USB

Double Turn Set



8460 Plain
8461 Diamond Knurled
8462 Linear Knurled
56mm Ø x 7mm roses

Finishes:
 BLK BN CCB GN MSB DRB OR RB USB

Privacy Set



8400 Plain
8410 Diamond Knurled
8456 Linear Knurled
56mm Ø x 7mm roses
57mm b/s bolt

Finishes:
 BLK BN CCB GN MSB DRB OR RB USB

> Magnetic latches available for use with passage and privacy sets.



NIDO

Product Dimensions

Verge - Plain

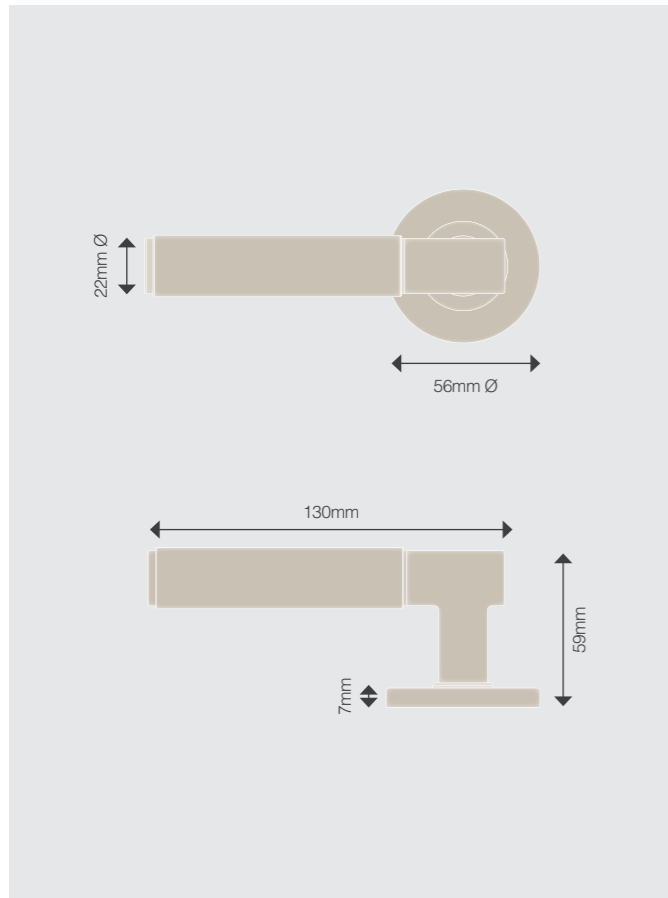

Verge - Diamond Knurled

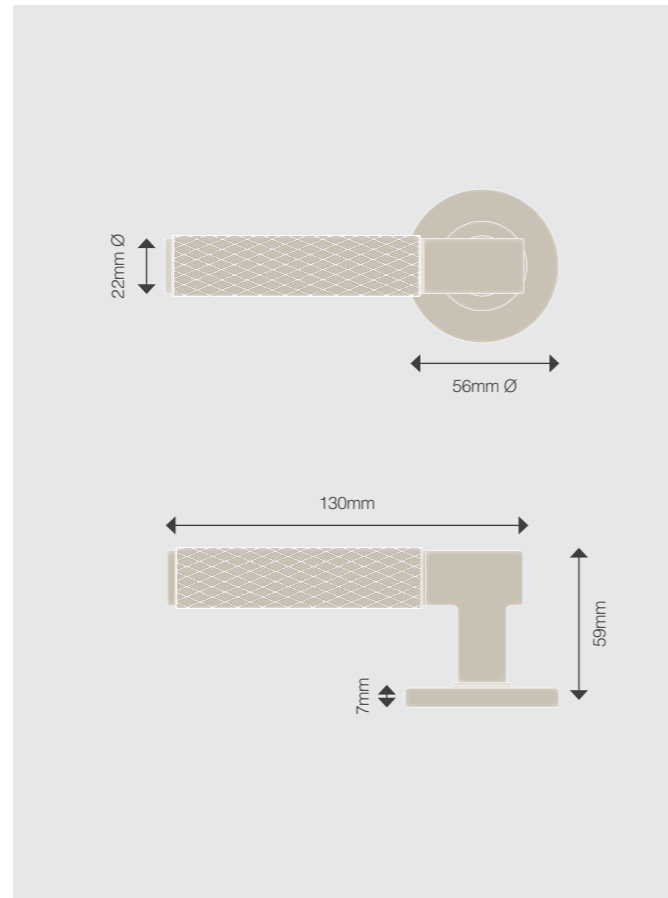

Verge - Linear Knurled

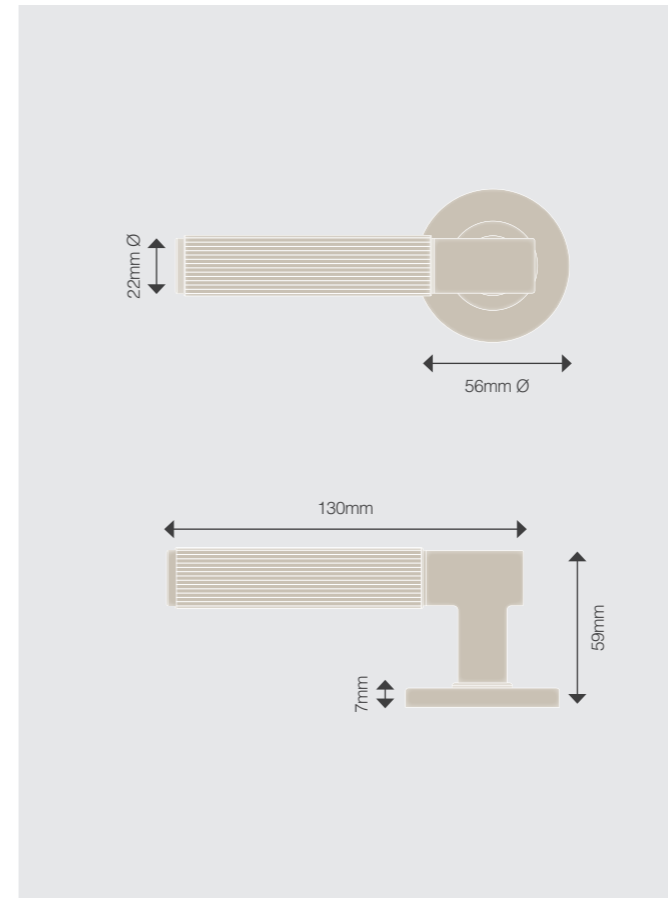

Modella

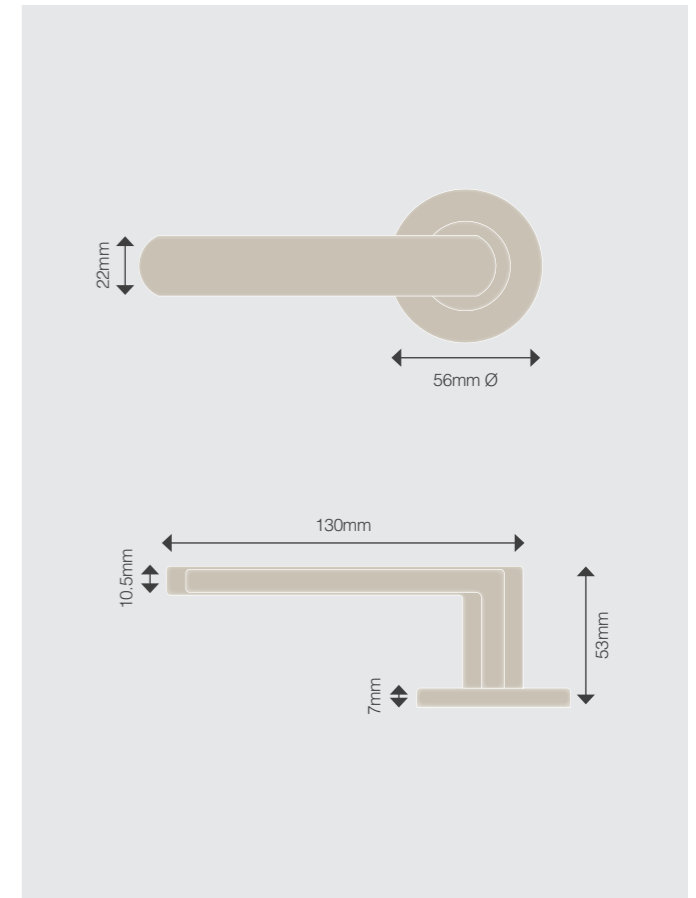

Lumina - Plain

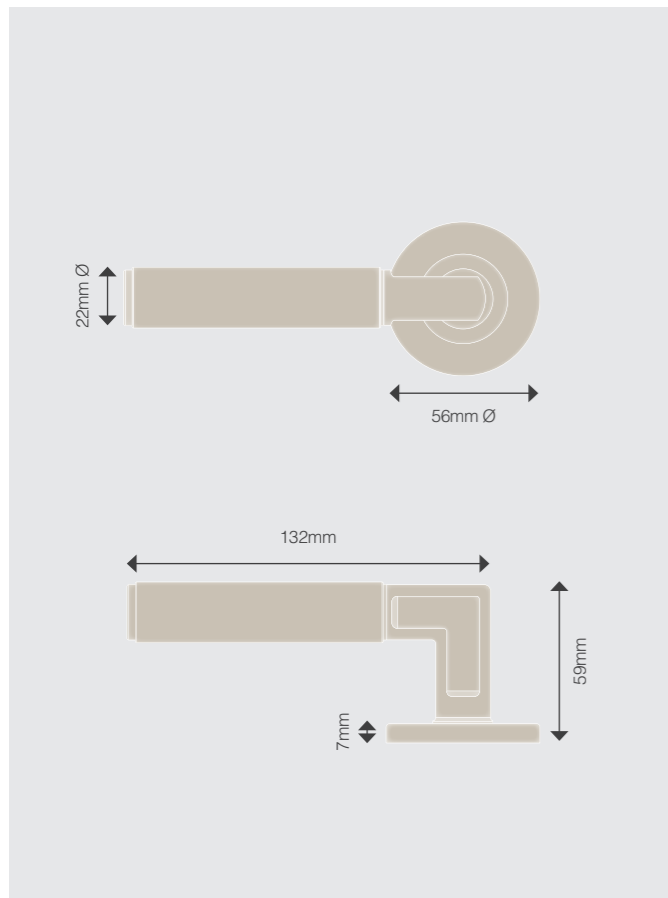

Lumina - Diamond Knurled

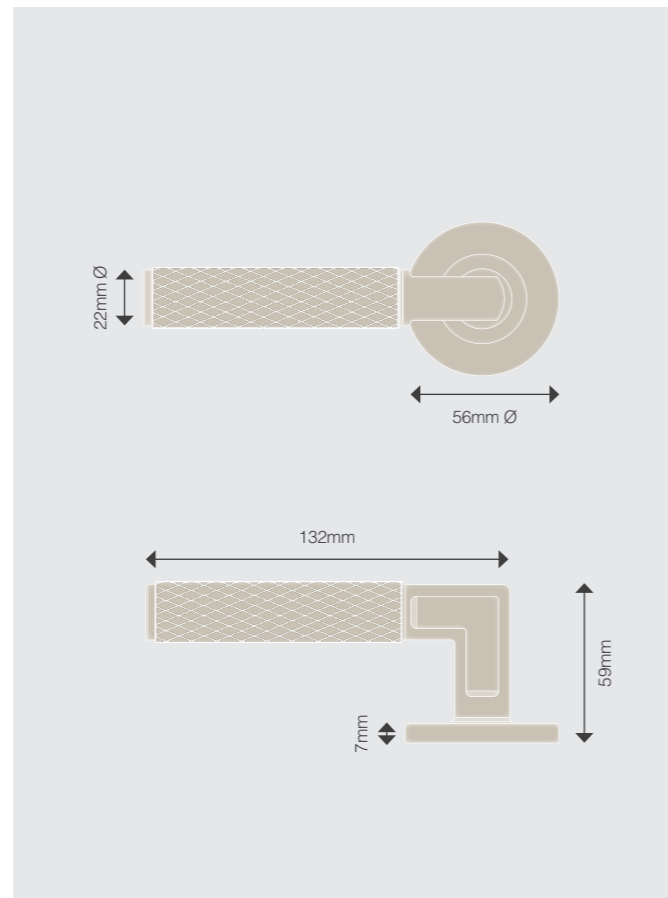

Lumina - Linear Knurled

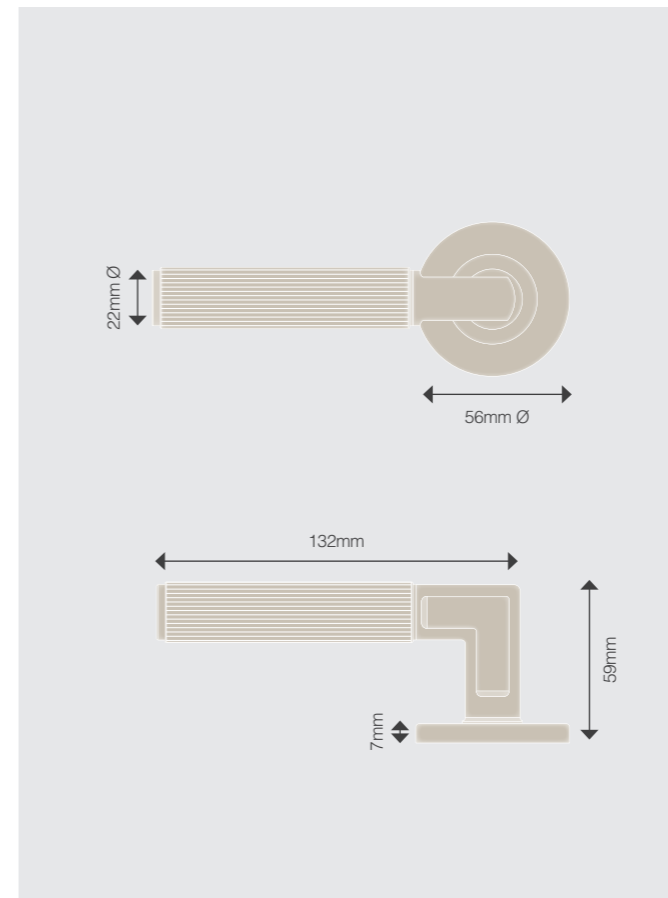

Backing Options

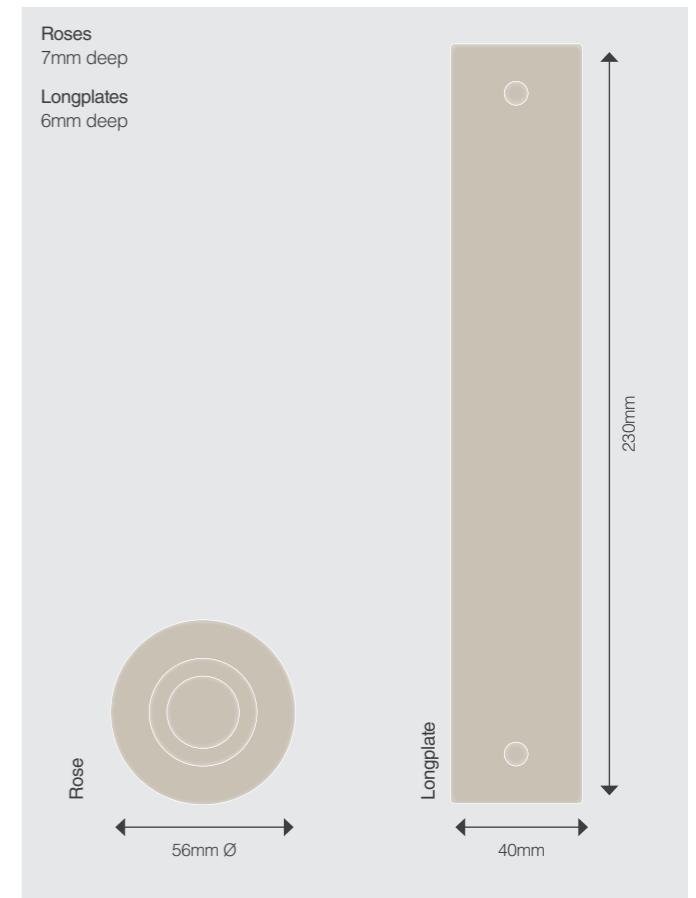



VERGE - DIAMOND KNURLED LEVER
IN MATT BLACK



MODELLA LEVER
IN BRUSHED NICKEL



LUMINA - DIAMOND KNURLED LEVER
IN ROMAN BRASS

GALAXY

The Galaxy range represents a contemporary selection of modern lever designs and finishes, mixing clean lines with smooth radiused edges for maximum comfort when opening your door.

GALAXY

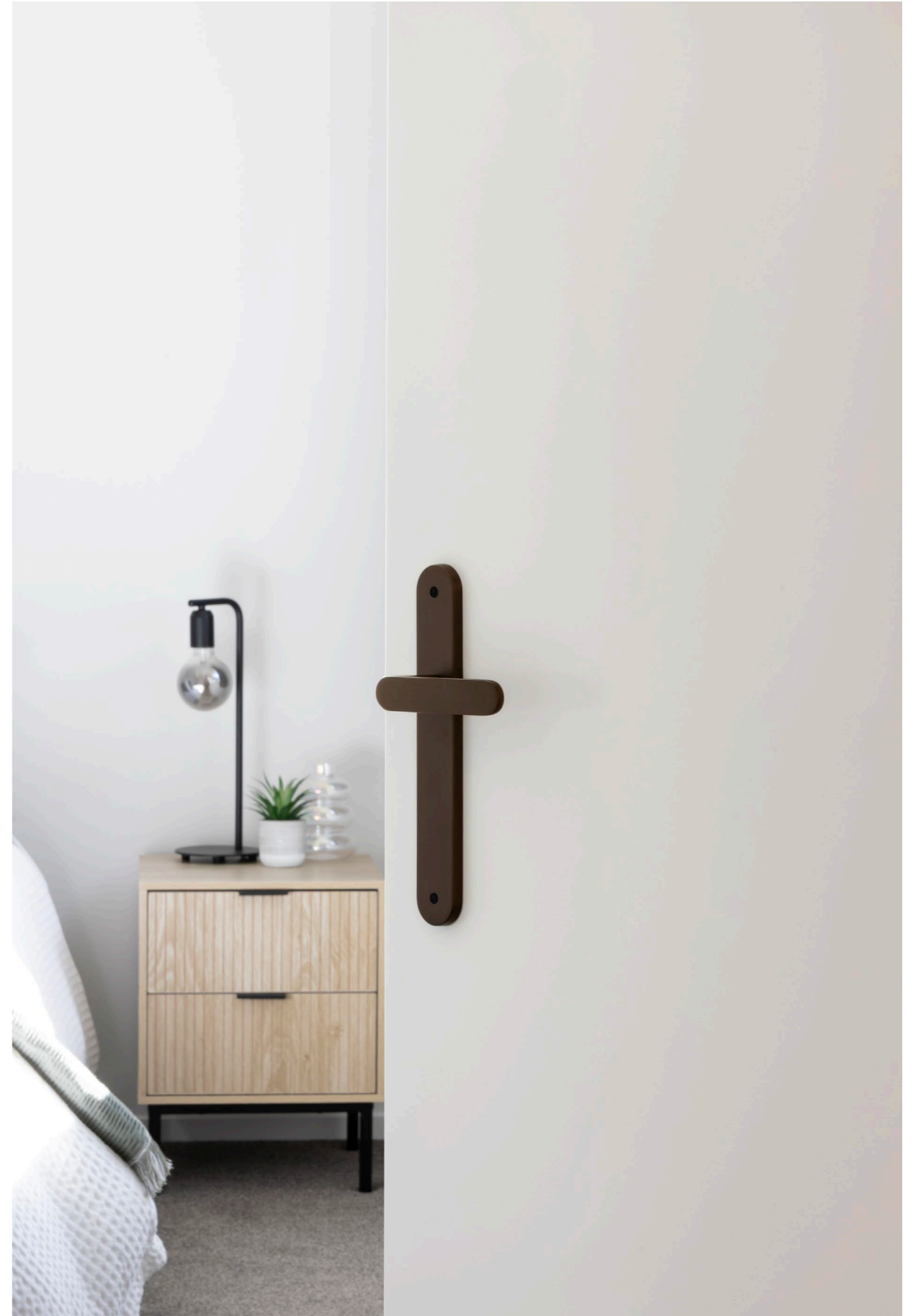

ASTRO LEVER ON OVAL LONGPLATE
IN COCOA BRONZE

GALAXY

Phoenix



Pegasus

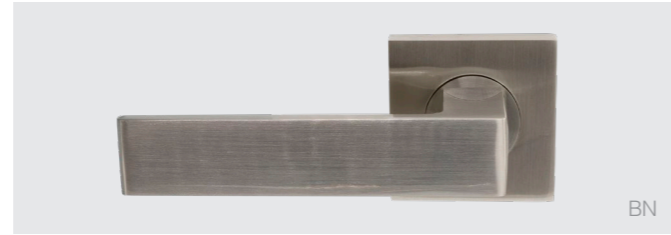

Qube

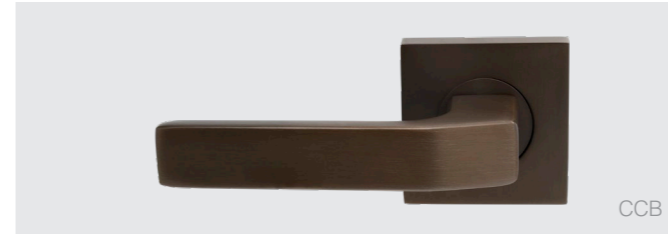

Vector



- Rose**
57mmØ x 10mm rose
- 7221 Lever Set
 - 7221D Dummy Lever
 - 7222 Passage Set
 - 7225 Privacy Set – Integrated
 - 7223 Privacy Set – Separate
 - 7224 Entrance Set

- Longplate**
240mm x 38mm x 8mm plate
- 7230 Lever Set
 - 7230LD Dummy Lever - LH
 - 7230RD Dummy Lever - RH
 - 7227 Passage Set
 - 7228 Privacy Set
 - 7229 E85 Entrance Set

- Square Rose**
57mm x 57mm x 10mm rose
- 7231 Lever Set
 - 7231D Dummy Lever
 - 7232 Passage Set
 - 7235 Privacy Set – Integrated
 - 7233 Privacy Set – Separate
 - 7234 Entrance Set



- Rose**
57mmØ x 10mm rose
- 7201 Lever Set
 - 7201D Dummy Lever
 - 7202 Passage Set
 - 7205 Privacy Set – Integrated
 - 7203 Privacy Set – Separate
 - 7204 Entrance Set

- Longplate**
240mm x 38mm x 8mm plate
- 7210 Lever Set
 - 7210LD Dummy Lever - LH
 - 7210RD Dummy Lever - RH
 - 7216 Passage Set
 - 7217 Privacy Set
 - 7218 E85 Entrance Set

- Square Rose**
57mm x 57mm x 10mm rose
- 7211 Lever Set
 - 7211D Dummy Lever
 - 7212 Passage Set
 - 7215 Privacy Set – Integrated
 - 7213 Privacy Set – Separate
 - 7214 Entrance Set



- Rose**
57mmØ x 10mm rose
- 7058 Lever Set
 - 7058D Dummy Lever
 - 7059 Passage Set
 - 7195 Privacy Set – Integrated
 - 7060 Privacy Set – Separate
 - 7085 Entrance Set

- Longplate**
240mm x 38mm x 8mm plate
- 7357 Lever Set
 - 7357LD Dummy Lever - LH
 - 7357RD Dummy Lever - RH
 - 7358 Passage Set
 - 7359 Privacy Set
 - 7360 E85 Entrance Set

- Square Rose**
57mm x 57mm x 10mm rose
- 7421 Lever Set
 - 7421D Dummy Lever
 - 7422 Passage Set
 - 7425 Privacy Set – Integrated
 - 7423 Privacy Set – Separate
 - 7424 Entrance Set



- Rose**
57mmØ x 10mm rose
- 7106 Lever Set
 - 7106D Dummy Lever
 - 7107 Passage Set
 - 7196 Privacy Set – Integrated
 - 7108 Privacy Set – Separate
 - 7110 Entrance Set

- Longplate**
240mm x 38mm x 8mm plate
- 7367 Lever Set
 - 7367LD Dummy Lever - LH
 - 7367RD Dummy Lever - RH
 - 7368 Passage Set
 - 7369 Privacy Set
 - 7370 E85 Entrance Set

- Square Rose**
57mm x 57mm x 10mm rose
- 7431 Lever Set
 - 7431D Dummy Lever
 - 7432 Passage Set
 - 7435 Privacy Set – Integrated
 - 7433 Privacy Set – Separate
 - 7434 Entrance Set



> Magnetic latches available for use with passage and privacy sets.

GALAXY

Apollo



MSB



MSB

Rose
57mmØ x 10mm rose
7015 Lever Set
7015D Dummy Lever
7033 Passage Set
7191 Privacy Set – Integrated
7034 Privacy Set – Separate
7080 Entrance Set

Longplate
240mm x 38mm x 8mm plate
7016 Lever Set
7016LD Dummy Lever - LH
7016RD Dummy Lever - RH
7267 Passage Set
7268 Privacy Set
7269 E85 Entrance Set

Finishes:
BLK BN CCB GN MSB PC

Astro



BN



BN

Rose
57mmØ x 10mm rose
7251 Lever Set
7251D Dummy Lever
7252 Passage Set
7255 Privacy Set – Integrated
7253 Privacy Set – Separate
7254 Entrance Set

Longplate
240mm x 38mm x 8mm plate
7256 Lever Set
7256LD Dummy Lever - LH
7256RD Dummy Lever - RH
7257 Passage Set
7258 Privacy Set
7259 E85 Entrance Set

Finishes:
BLK BN CCB GN MSB PC

> Magnetic latches available for use with passage and privacy sets.

Accessories

Cavity Suite Ultra



BN

5401 Passage Set
5402 Privacy Set
5403 Locking Set

Finishes:
BLK BN CCB GN MSB

Privacy Set - Auxillary



MSB

9034 Round (pic)
9044 Square
60mm b/s bolt
54mm Ø rose
5mm spindle

Finishes:
BLK BN CCB GN MSB

Concealed Skirting Fix Doorstops



BLK

5240
85mm x 30mm

Finishes:
BLK BN CCB GN MSB

Flush Pull



GN

5317 142mm x 42mm
5318 158mm x 42mm
5319 190mm x 42mm

Finishes:
BLK BN CCB GN MSB

Radius Hinge



MSB

5904
89mm x 60mm

Finishes:
BLK BN CCB GN MSB

Floor Mount Doorstops



SS

5262
80mm x 19mm

Finishes:
BLK BN GN

Edge Pull



CCB

5411 85mm x 26mm

Finishes:
BLK BN CCB GN MSB

Lift Off Hinge

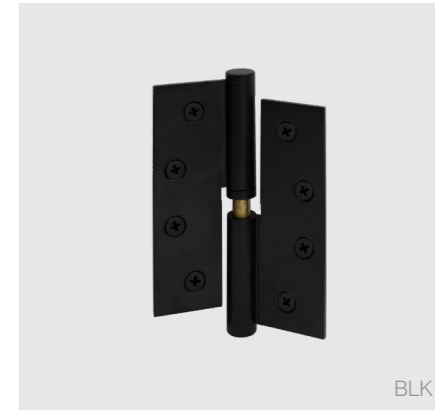

BLK

5910 Lift Off Hinge LH - Handing (pic)
5911 Lift Off Hinge RH - Handing
100mm x 75mm
Solid Brass

Finishes:
BLK BN GN MSB

Floor Mount Doorstops



CCB

5256
38mm

Finishes:
BLK BN CCB GN MSB

GALAXY

Product Dimensions

Phoenix

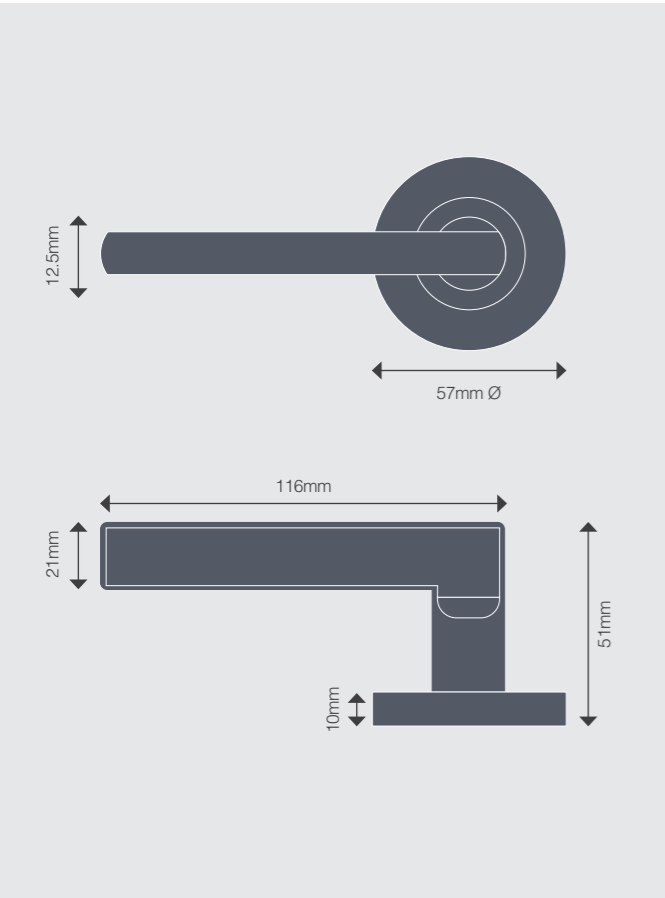

Pegasus

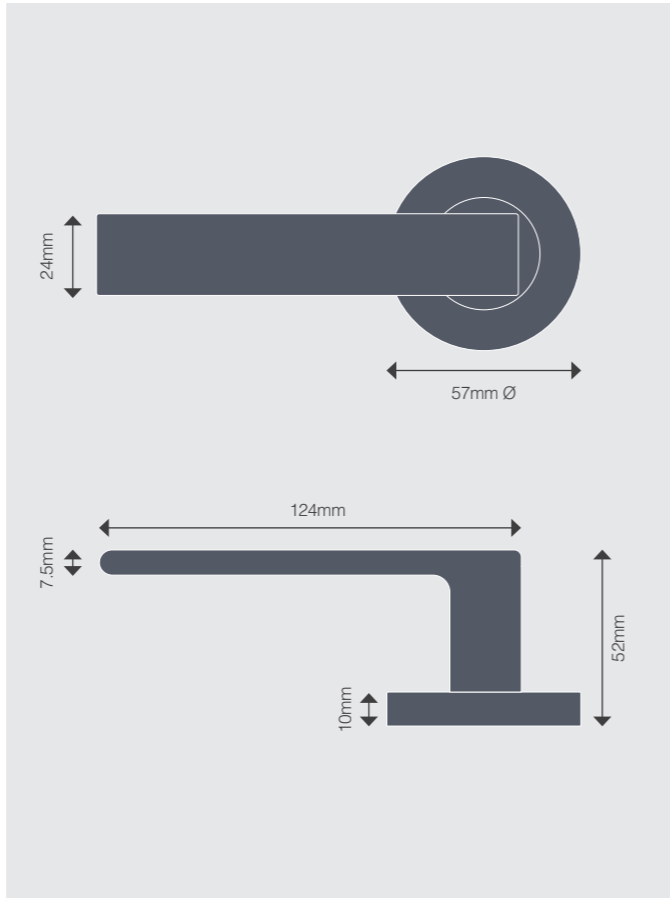

Apollo

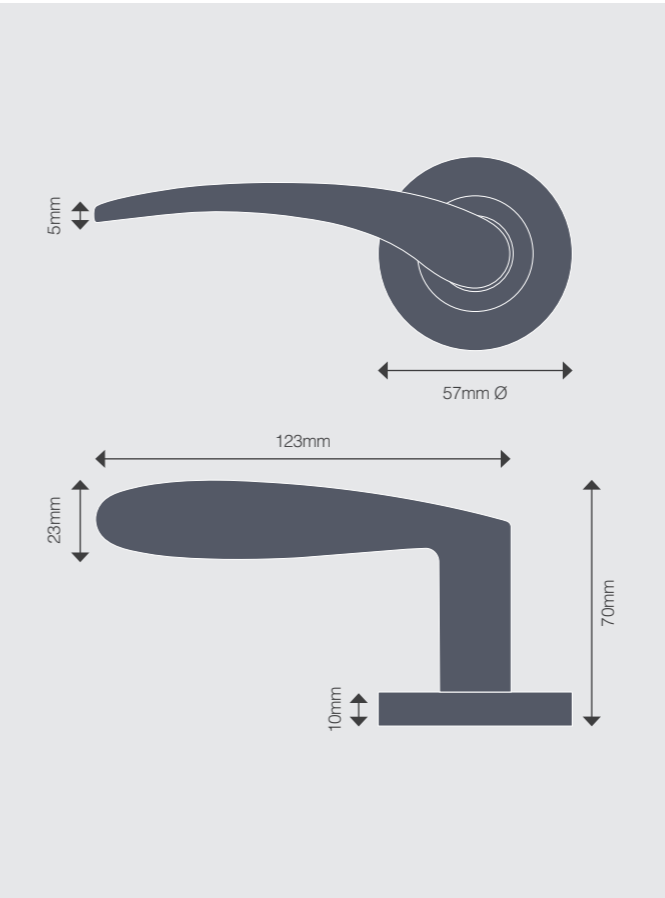

Astro

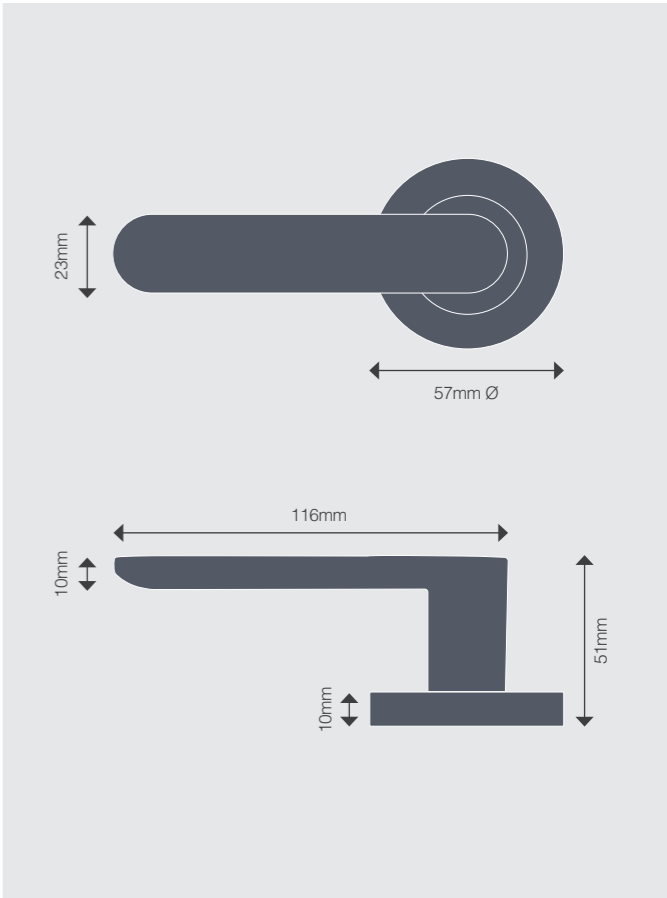

Qube

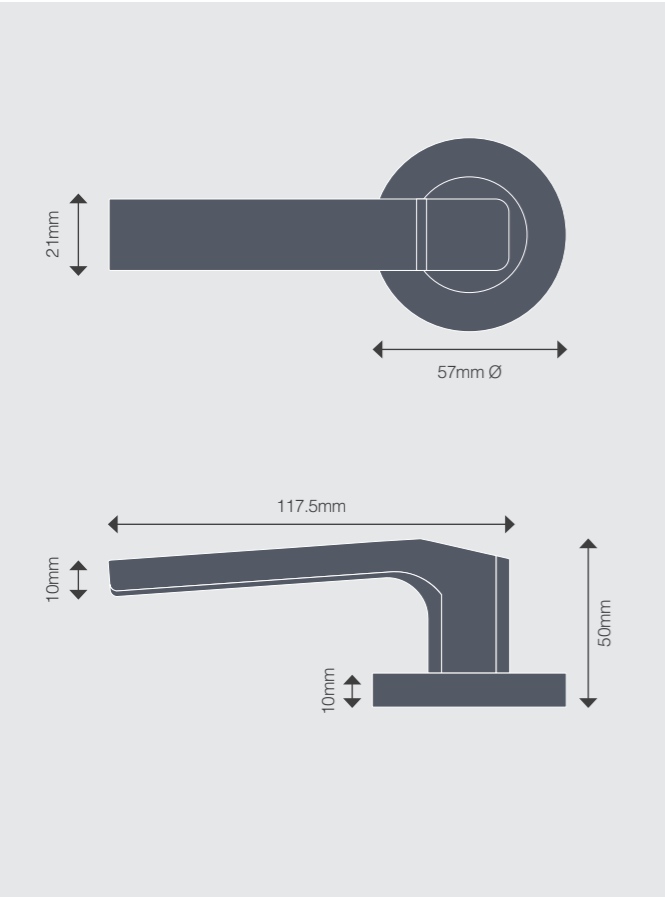

Vector

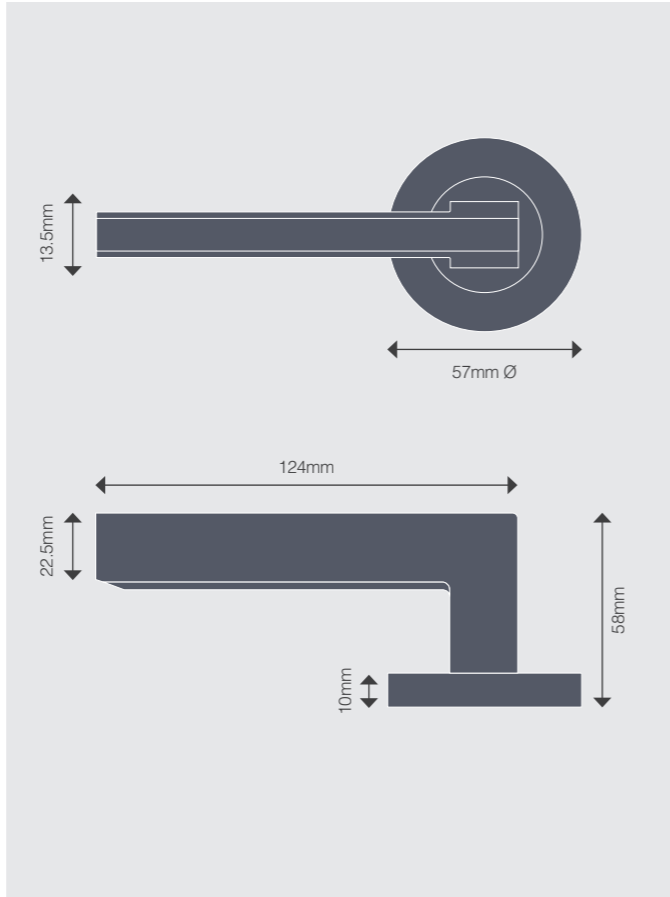

Backing Options

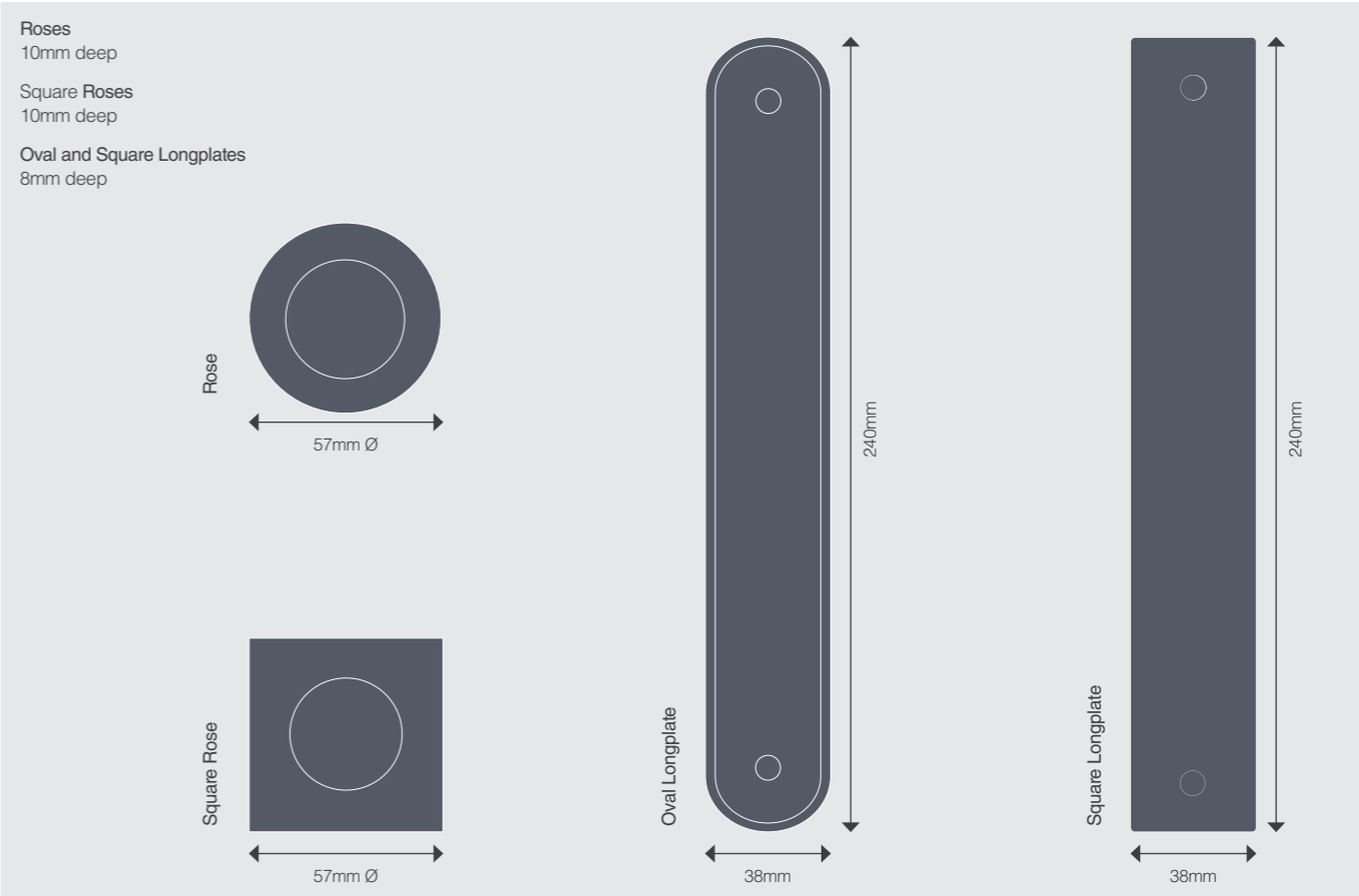



ASTRO OVAL LONGPLATE
IN COCOA BRONZE

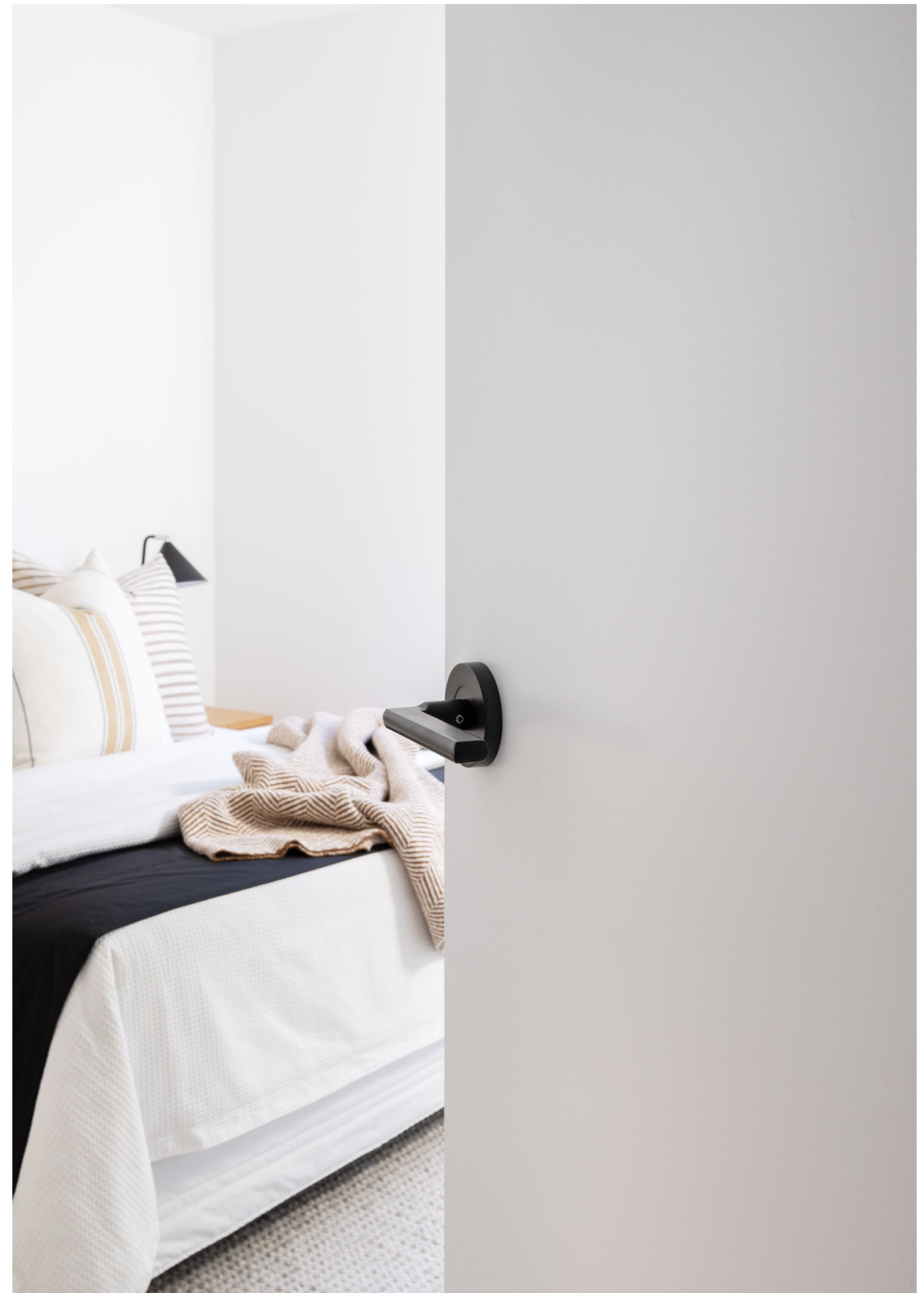

PHOENIX LEVER
IN MATT BLACK

CABINET HANDLES

CABINET HANDLES



PLANAR KNOB
IN BRUSHED NICKEL

CABINET HANDLES

Planar Handle



GN

code	crs	o/a	knurl	wide	pj*
6502	130	160	plain	15	41
6503	230	260	plain	15	41
6504	330	360	plain	15	41

Vertex Handle



BLK

code	crs	o/a	knurl	wide	pj*
6508	130	160	diamond	15	41
6509	230	260	diamond	15	41
6510	330	360	diamond	15	41

Orizon Handle



USB

code	crs	o/a	knurl	wide	pj*
6514	130	160	linear	15	41
6515	230	260	linear	15	41
6516	330	360	linear	15	41

*projection will increase to 44mm if the bases are used on the handles.

Finishes:



All measurements in the above tables are mm.

Planar Knob



BLK

6523 Plain
38mm Ø
40.5mm pj*

Vertex Knob



OR

6524 Diamond Knurled
38mm Ø
40.5mm pj*

Orizon Knob



BN

6525 Linear Knurled
38mm Ø
40.5mm pj*

*projection will increase to 43.5mm if the bases are used on the knobs.

Finishes:



Planar T-Bar



DRB

6520 Plain
70mm o/a
41.5mm pj*
15mm Ø bar

Vertex T-Bar



MSB

6521 Diamond Knurled
70mm o/a
41.5mm pj*
15mm Ø bar

Orizon T-Bar



RB

6522 Linear Knurled
70mm o/a
41.5mm pj*
15mm Ø bar

*projection will increase to 44.5mm if the bases are used on the t-bar.

Finishes:



Backing Plate

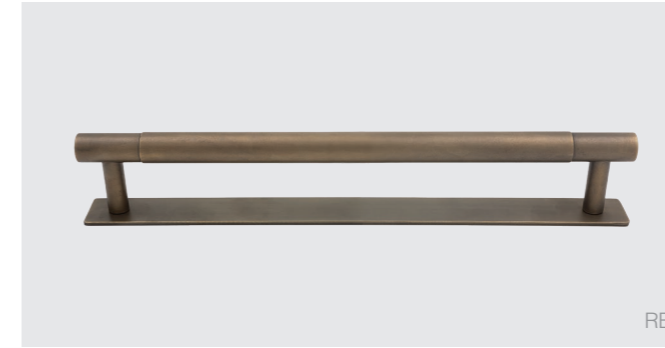

RB

For retro-fitting cabinetry backing plates can be ordered separately.

6526 160mm
6527 260mm
6528 360mm

Finishes:



Mounting Disc



DRB

Optional round mounting discs included with all Brass Cabinet Handles and Knobs.

Product Dimensions

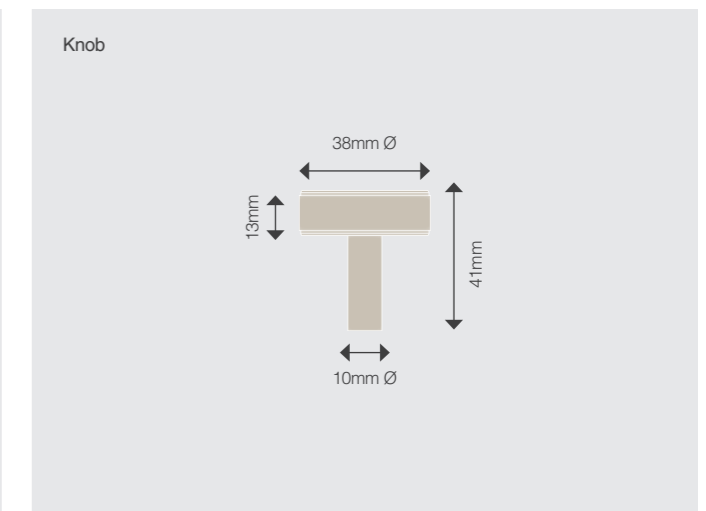
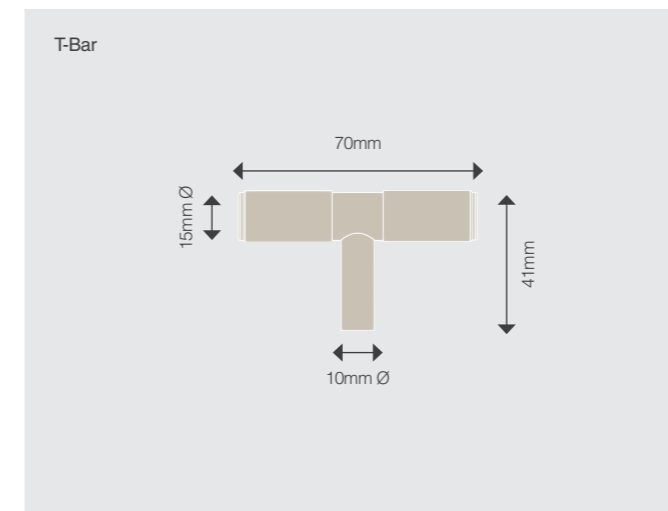



CABINET KNOBS
IN MATT BLACK



CABINET T-BARS
IN MATT BLACK



CABINET HANDLES
IN MATT BLACK

ACCESSORIES

DOOR ACCESSORIES



REVERSE BARREL BOLT
IN UNLACQUERED SATIN BRASS

Floor Mount



BN

5281 Solid Brass – Plain
38mm x 30mm

Finishes:



Available in all special finishes refer to page 75

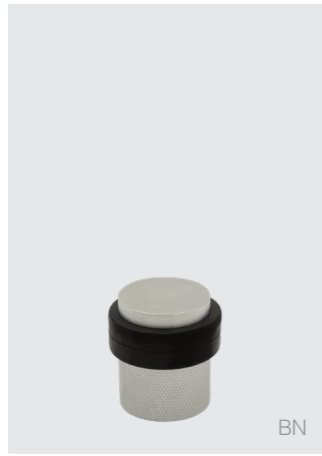

BN

5293 Solid Brass – Diamond Knurled
38mm x 30mm

Finishes:



Available in all special finishes refer to page 75

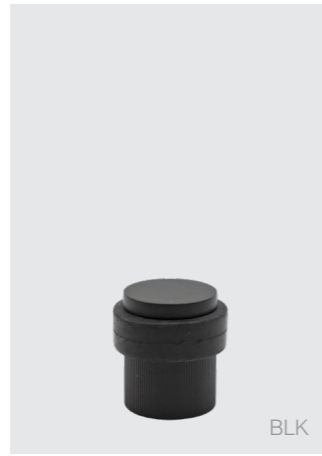

BLK

5294 Solid Brass – Linear Knurled
38mm x 30mm

Finishes:



Available in all special finishes refer to page 75

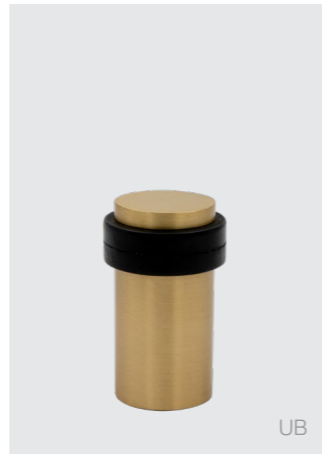

UB

5282 Solid Brass
60mm x 30mm

Finishes:



Available in all special finishes refer to page 75

Floor Mount

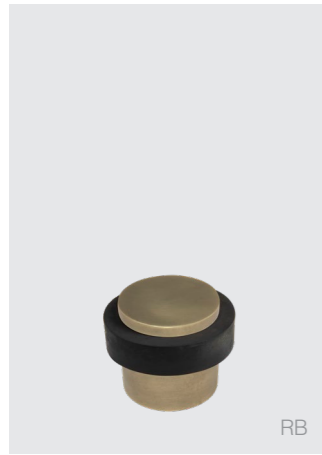

RB

5256 Solid Brass
38mm x 38mm

Finishes:



Available in all special finishes refer to page 75

Skirting Mount

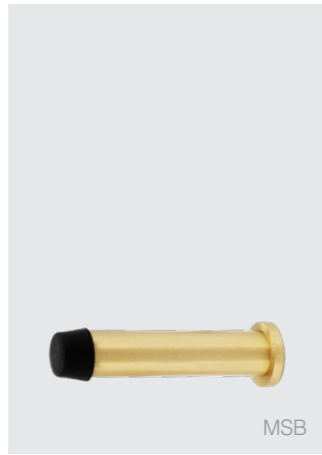

MSB

5280 Solid Brass – Plain
85mm x 25mm

Finishes:



Available in all special finishes refer to page 75

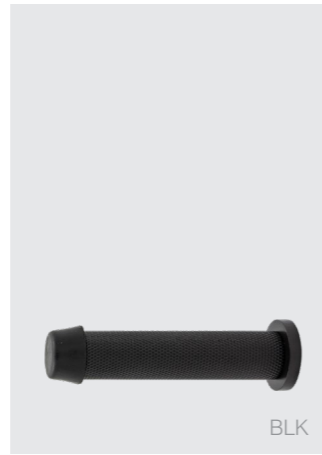

BLK

5291 Solid Brass – Diamond Knurled
85mm x 25mm

Finishes:



Available in all special finishes refer to page 75

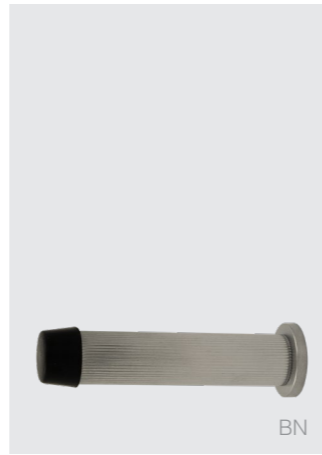

BN

5292 Solid Brass – Linear Knurled
85mm x 25mm

Finishes:



Available in all special finishes refer to page 75

Skirting Mount

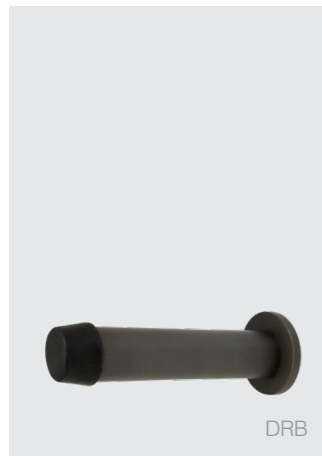

DRB

5240 Solid Brass
85mm x 30mm

Finishes:



Available in all special finishes refer to page 75

Door Holder



PB

5133 Engaged length 88mm

Finishes:



Available in all special finishes refer to page 75

Door Magnets

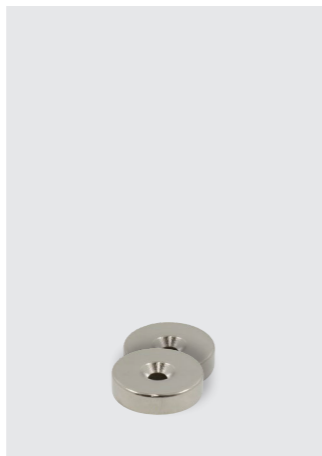

1180 25mm Ø x 7mm

> Made from N42 grade raw material for superior magnet strength
> Includes rubber buffers for a soft close



1464 Cup Magnet
25mm Ø x 7mm

Flush Pull



GN*

660 170mm x 36mm

Finishes:



* This item is a deeper GN than our standard products

halliday
baillie

Soft Edge Flush Pull



RB

860 170mm x 42mm

Finishes:

Available in all special finishes refer to page 75

halliday
baillie

Button Activated Edge Pull



GN*

680 100mm x 49mm

Finishes:



* This item is a deeper GN than our standard products

halliday
baillie

Sliding Door Key Lock



GN*

630 250mm x 36mm
55mm b/s
Cylinder not included
Minimum thickness 38mm

Finishes:



* This item is a deeper GN than our standard products

halliday
baillie

Sliding Door Privacy Lock



BN

690 170mm x 36mm
55mm b/s
Minimum thickness 38mm
Please use 690/35 for 35mm thickness

Finishes:



* This item is a deeper GN than our standard products

halliday
baillie

Soft Edge Privacy Lock



DRB

890 170mm x 42mm
Minimum thickness 35mm

Finishes:

Available in all special finishes refer to page 75

halliday
baillie

Cavity Suite Ultra



BN

5401 Passage Set
128mm x 40mm

Finishes:



BLK

5402 Privacy Set
152mm x 40mm
Door thickness 34mm–51mm

Finishes:



GN

5403 Locking Set
152mm x 40mm
Door thickness 35mm–55mm

Finishes:



Magnetic Latch



1444 60mm b/s 1446 70mm b/s

Finishes:
 BLK BN GN MSB

Available in all special finishes refer to page 75

Tubular Latch



1131 60mm b/s 1101 70mm b/s

Finishes:
 BLK CCB GN MSB SS PC

Available in all special finishes refer to page 75

Heavy Duty Tubular Latch



1172 57mm b/s

Finishes:
 BLK GN MSB SS

Available in all special finishes refer to page 75

Straight Throw Reverse Barrel Bolt



5225 150mm x 31mm
 9.6mm pin
 40mm throw

> Can be made to custom length

Finishes:
 BN SC

Available in all special finishes refer to page 75



5226 100mm x 25mm
 7.6mm pin
 35mm throw

Finishes:
 BN SC

Available in all special finishes refer to page 75

Straight Throw Flush Bolt

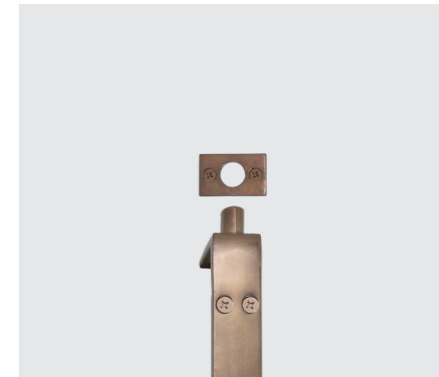

5348 400mm x 25mm
 12mm heavy duty bolt
 18mm throw

Finishes:
 BN SC

Available in all special finishes refer to page 75

Privacy Bolt



1253 60mm b/s 1254 70mm b/s

Finishes:
 BLK BN GN MSB

Available in all special finishes refer to page 75

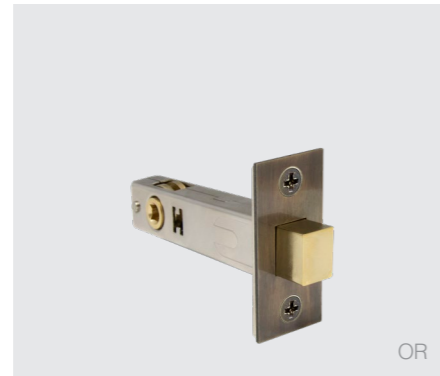

1203 70mm b/s

Finishes:
 SS

Available in all special finishes refer to page 75

Heavy Duty Tubular Privacy Bolt



1173 57mm b/s

Finishes:
 BLK GN MSB SS

Available in all special finishes refer to page 75

Necked Outward Reverse Barrel Bolt



5273 150mm x 31mm
 25mm throw
 16mm offset

Finishes:
 BN SC

Available in all special finishes refer to page 75

Straight Throw Flush Bolt



5308 151mm x 25mm
 12mm heavy duty bolt
 18mm throw

Finishes:
 BN SC

Available in all special finishes refer to page 75

Straight Throw Flush Bolt



5348 400mm x 25mm
 12mm heavy duty bolt
 18mm throw

Finishes:
 BN SC

Available in all special finishes refer to page 75

Hinge



5906 Loose Pin Tip
 5902 Fixed Pin Flat Tip (no PC)
 100mm x 75mm

Finishes:
 BLK BN CCB GN MSB

Available in all special finishes refer to page 75

Lift Off Hinges



5910 LH - Handing
 100mm x 75mm

Finishes:
 BLK BN GN MSB

Available in all special finishes refer to page 75



5911 RH - Handing
 100mm x 75mm

Finishes:
 BLK BN GN MSB

Available in all special finishes refer to page 75

ARLU Invisible NEO

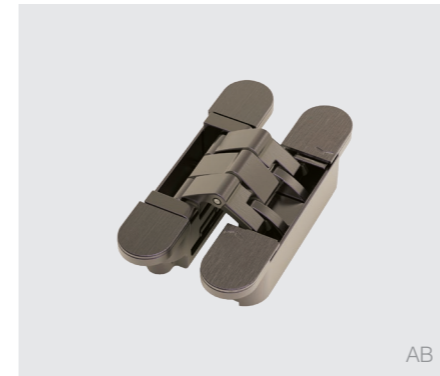

9811 Invisible NEO S-5
 Min. Door Thickness 33mm
 Up to 80kg doors
 9812 Invisible NEO M-6
 Min. Door Thickness 36mm
 Up to 100kg doors

> 3D adjustability (height, width, and depth)
 without taking the door off

Finishes:
 AB BLK PB SS

Available in all special finishes refer to page 75

ARLU Pivotica Pro

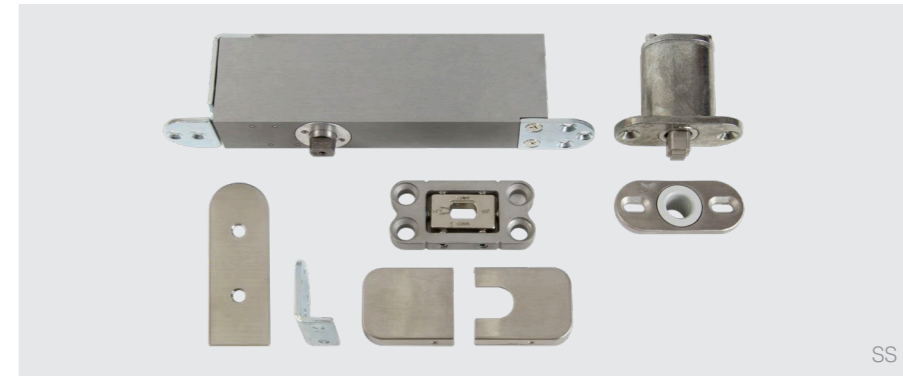

9801 100 - F90
 Hydraulic Spring
 Fixed Positions: Closed & 90°
 Up to 100kg door
 Adjustable bottom plate
 9805 150 - F90
 Hydraulic Spring
 Fixed Positions: Closed & 90°
 Up to 150kg door

Finishes:
 SS

Available in all special finishes refer to page 75

9804 Built-in mounting part only
 9803 Pivotica Pro 100 Cover Plates
 9807 Pivotica Pro 150 Cover Plates



PIVOTICA PRO
IN STAINLESS STEEL



FLOOR MOUNT DOORSTOP
IN DARK ROMAN BRASS



FIXED PIN FLAT TIP HINGE
IN OIL RUBBED BRONZE



SKIRTING MOUNT DOORSTOP
IN MATT SATIN BRASS

WINDOW HARDWARE

Fanlight Stays



5385 300mm
 > Suits windows with and without weather seals

Finishes:
 BN GN SC

Available in all special finishes except Powdercoat refer to page 75



5185 250mm
 > Suits windows with and without weather seals

Finishes:
 BN GN SC

Available in all special finishes except Powdercoat refer to page 75

Round Telescopic Stay

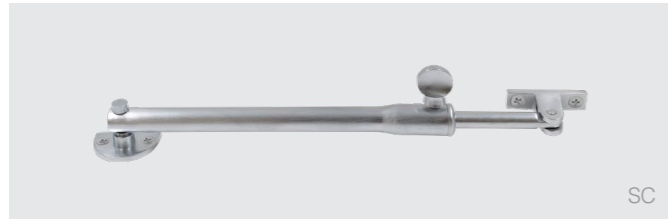

5205 240mm - 375mm
 > Suits windows with and without weather seals

Finishes:
 BN SC

Available in all special finishes except Powdercoat refer to page 75

Round Restrictor Stay



5355 140mm - 180mm
 > Suits windows with and without weather seals

Finishes:
 BN SC

Available in all special finishes except Powdercoat refer to page 75

Casement Stays

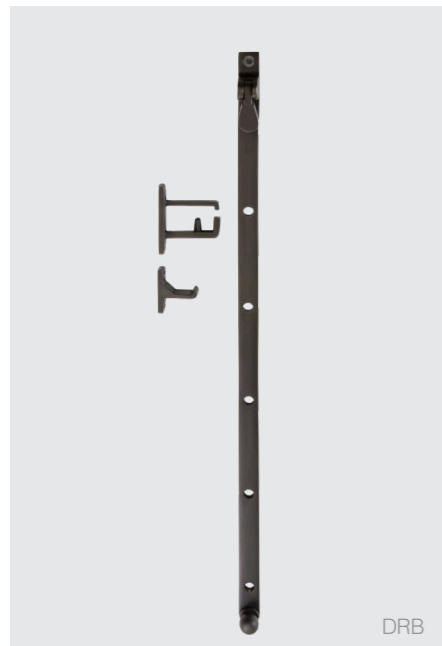

5184 350mm
 > Suits windows with and without weather seals

Finishes:
 BN GN SC

Available in all special finishes except Powdercoat refer to page 75

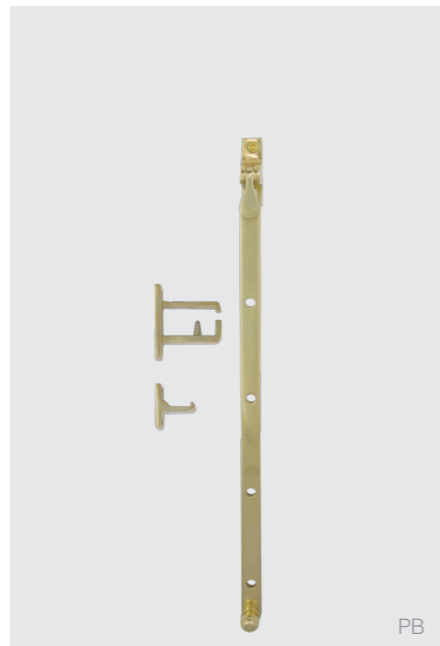

5384 300mm
 > Suits windows with and without weather seals

Finishes:
 BN GN SC

Available in all special finishes except Powdercoat refer to page 75

Quadrant Stay



5086
 > Suits windows with and without weather seals

Finishes:
 BN GN SC

Available in all special finishes except Powdercoat refer to page 75

WINDOW HARDWARE



FANLIGHT STAY
 IN OIL RUBBED BRONZE



SASH LIFTS AND REVERSE BARREL BOLT
IN UNLACQUERED SATIN BRASS

Spring Catches

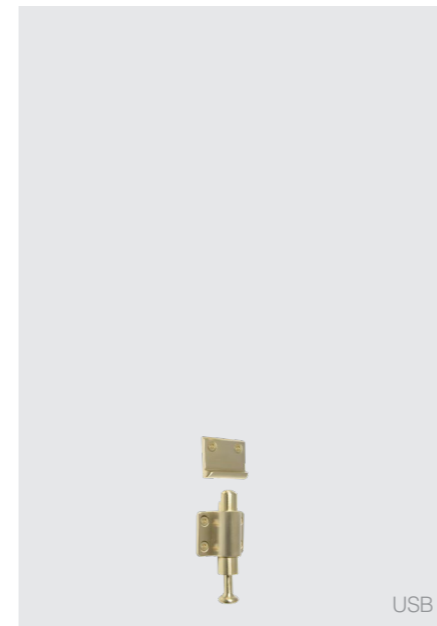

5194 Standard

- > Includes extended keeper to suit weather seal windows and doors
- > Other lengths available to order — please enquire

Finishes:

Available in all special finishes except Powdercoat refer to page 75

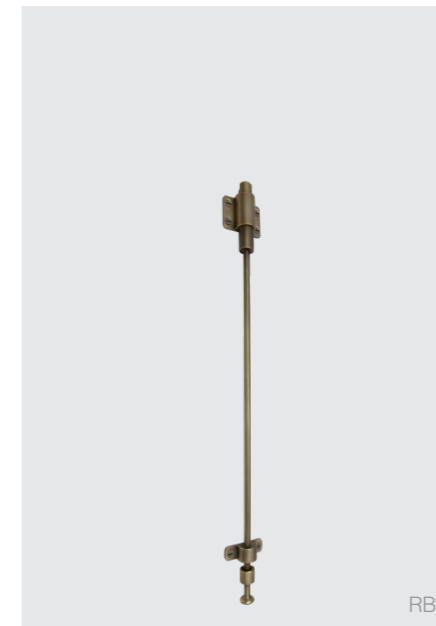

5361 300mm



5362 450mm

Window Fasteners



5343 Qube

- > Narrow 31mm overall protrusion

Finishes:

Available in all special finishes except Powdercoat refer to page 75



5344 Vulcan

Finishes:

Available in all special finishes except Powdercoat refer to page 75



5386 Traditional

- > Suits timber windows with or without weather seals

Finishes:

Available in all special finishes except Powdercoat refer to page 75

Sash Fastener



5025 15mm profile keeper

Finishes:

Available in all special finishes except Powdercoat refer to page 75

Sash Lift Hooks



5026 50mm x 26mm
30mm pj

Finishes:

Available in all special finishes refer to page 75



5360 39mm x 12mm
23mm pj

Finishes:

Available in all special finishes refer to page 75



VERGE - DIAMOND KNURLED LEVER ON LONGPLATE
IN GRAPHITE NICKEL

WINDSOR FINISHES

Brushed Nickel

Nickel electroplating is made up of several layers of colour then brushed and finished with a gloss clearcoat to protect the finish. Applied to brass, stainless steel, zinc alloy and aluminium dependent on the item.

Satin Chrome

Satin Chrome is derived from a heavy chrome electroplate that is brushed back to achieve a consistent and seamless matt finish.

Matt Black

Matt Black is a bold finish and resembles a deep midnight tone. The finish is applied with electroplating, with some items powdercoated to achieve matching finishes across the range.

Graphite Nickel

Graphite Nickel resembles tones similar to 'gunmetal' and offers a softer look than black whilst still adding texture and depth to a home.

Cocoa Bronze

A rich, dark finish with warm undertones that subtly blend deep brown and soft metallic hues. Its low-sheen surface offers a sense of understated luxury and sophisticated matte lustre.

Matt Satin Brass

An elegant brushed brass finish that emits a soft luminous sheen through the added matt lacquer.

Antique Bronze

A traditional bronze finish with shades of rich chocolate and protected with a gloss lacquer. Often used in heritage homes as complements natural wooden doors and windows.

Polished Brass

A timeless classic, this mirror finish coordinates well with many other fixtures in the home and can appear traditional or modern depending on the lever style it is applied to.

Dark Roman Brass

A smoky charcoal finish that after bronzing is rubbed back by hand to achieve lighter caramel edges that radiate through like twilight adding depth to your colour palette.

Natural Bronze

Warm autumn hues that bring through texture similar to stone. This unlacquered finish is left to patina naturally over time.

Oil Rubbed Bronze

This finish offers bronze tones varying from a dark truffle through to champagne by hand rubbing the hardware with oil to achieve the natural patina appearance.

Roman Brass

A medium toned bronze finish that depicts shadows of dusk. It is rubbed back by hand and left to patina naturally over time.

Rumbled Brass

Our most textured finish, this medium brass tone is favoured for its perfect imperfections.

Unlacquered Brass

A luxurious golden colour with the same distinctive honey look as Polished Brass but non-lacquered. This is brass in its raw and natural form.

Unlacquered Satin Brass

This brushed brass finish is more subtle than its lacquered counterpart and offers a soft lustrous sheen that will age naturally.

Powdercoat

We powdercoat using colours from the New Zealand Dulux Powders Range.

















Finishes	Italian	NIDO	Galaxy	
Brushed Nickel	○	○	○	
Satin Chrome	○			
Matt Black		○	○	
Graphite Nickel		○	○	
Cocoa Bronze		○	○	
Matt Satin Brass	●*	○		
Antique Bronze	●*			
Polished Brass	●*			
Dark Roman Brass	●	●		
Natural Bronze	●			
Oil Rubbed Bronze	●			
Roman Brass	●	●		
Rumbled Brass	●			
Unlacquered Brass	●			
Unlacquered Satin Brass	●			
Powdercoat	●		●	

Table Key

○ Stocked—7 day lead time

●* Special/Lacquered*—21 day lead time

● Special/Living—21 day lead time

● Special/Powdercoat—21 day lead time

* Lacquered finishes not recommended for external use

TECHNICAL INFORMATION

Italian

Rose

- > **Lever Set**
Includes Levers only
- > **Dummy Lever**
Includes single Lever and 1152 Dummy Mount
- > **Passage Set***
Includes Levers and 1172 Tubular Latch - 57mm b/s (excludes Large Rose option)
- > **Privacy Set***
Includes Levers, 1172 Tubular Latch, 1173 Tubular Bolt and 8188 Privacy Turn & Release - 57mm b/s
- > **Entrance Set E85**
Includes Levers, 1403 or 1143 Euro Mortice Lock (finish dependent), 1148 Euro Cylinder & Turn and 8189 Euro Escutcheons

Longplate

- > **Lever Set**
Includes Levers only
- > **Dummy Lever**
Includes single LH or RH Lever and 1152 Dummy Mount
- > **Passage Set***
Includes Longplates and 1172 Tubular Latch - 57mm b/s
- > **Privacy Set P85***
Includes P85 Longplates, 1172 Tubular Latch, 1173 Tubular Bolt and 8055 Privacy Turn & Release - 57mm b/s
- > **Entrance Set E48**
Includes E48 Longplates, 1115 Euro Mortice Lock and 1148 Euro Cylinder & Turn
- > **Entrance Set E85**
Includes E85 Longplates, 1403 or 1143 Euro Mortice Lock (finish dependent) and 1148 Euro Cylinder & Turn

NIDO

Rose

- > **Lever Set**
Includes Levers only
- > **Dummy Lever**
Includes single Lever and 1152 Dummy Mount
- > **Passage Set***
Includes Levers and 1172 Tubular Latch - 57mm b/s
- > **Privacy Set***
Includes Levers, 1172 Tubular Latch and 8400/8410/8455 Turn & Release Set - 57m b/s
- > **Entrance Set E85**
Includes Levers, 1403 or 1143 Euro Mortice Lock (finish dependent), 1148 Euro Cylinder & Turn and 8420 Euro Escutcheons

Longplate

- > **Lever Set**
Includes Levers only
- > **Dummy Lever**
Includes single LH or RH Lever and 1152 Dummy Mount
- > **Passage Set***
Includes Levers and 1172 Tubular Latch - 57mm b/s
- > **Privacy Set***
Includes P85 Longplates, 1172 Tubular Latch, 1173 Tubular Bolt and 8451/8452/8457 Turn & Escape
- > **Entrance Set E85**
Includes E85 Longplates, 1403 or 1143 Euro Mortice Lock (finish dependent) and 1148 Euro Cylinder & Turn

Galaxy

- > **Lever Set**
Includes Levers only
- > **Dummy Lever**
Includes single Lever handle and 1152 Dummy Mount
- > **Passage Set ***
Includes Levers and 1357 Tubular Latch - 60mm b/s

- > **Privacy Set***
Includes Levers, 1357 Tubular Latch and 9034 Auxiliary Privacy Set - 60mm b/s
- > **Entrance Set E85**
Includes Levers, 1143 Euro Mortice Lock, 9035 Escutcheons and 1148 Euro Cylinder & Turn
- > **Integrated Privacy Set**
Includes Levers and 1358 Tubular Privacy Latch - 60mm b/s

* Magnetic latches available for use with passage and privacy sets.

Abbreviations

Ø	Diameter	pj	Projection
o/a	Overall length	b/s	Backset
crs	Screw/bolt centres	c/s	Case size

PASSAGE



PRIVACY



ENTRANCE



SUPPORT

Returns

All stocked finish products can be returned. All special finishes and custom products are non-returnable. For more information please refer to the Windsor Hardware returns policy or contact our team.

Warranty

At Windsor we stand behind the quality of our products 100% and are pleased to offer a lifetime mechanical warranty on all products in residential applications within this catalogue. Warranty on finishes will be at Windsor's discretion. For more information please refer to the Windsor Hardware warranty policy or contact our team.

Care and Maintenance

Our hardware collection is available in a range of finishes, including both stock and hand-finished brass options crafted in our workshop. Learn the essential care techniques to ensure the durability of your chosen hardware finish by scanning the QR code below for detailed maintenance instructions.



CHALET ENTRANCE SET WITH REBATE
IN UNLACQUERED SATIN BRASS

PROJECT HIGHLIGHT

Project Hicks Cottage

Hardware Italian Charleston in Oil Rubbed Bronze

Location Queenstown, New Zealand

Nestled within the scenic Shotover Country (a short drive from Windsor head office) the once-dilapidated 1867 cottage, crafted by pioneer Thomas Hicks, stands as Queenstown's heritage landmark. Formerly a shearing shed and draught horse haven, this Category 3 listed historic gem has undergone a remarkable transformation, orchestrated by a visionary interior designer and builder/owner. Preserving its pioneering legacy, meticulous efforts were undertaken. The iconic timber shingles roof, symbolizing its historical significance, was safeguarded under a new iron layer treated with hydrochloric acid for an authentic patina. A crumbling rubble stone chimney, rebuilt using local river stones, mirrors the original 1870s pattern.

This extensive project included lifting and placing the cottage on concrete blocks, revealing original wooden roof shingles and incorporating new cedar weatherboard clad with old beech sarking. A new front door and window frames were added, replicating the originals. Seamlessly blending modern luxury with historical charm, the interior offers first-class accommodation through Hello Guest, inviting visitors to reconnect with Queenstown's captivating history and beauty. The Oil Rubbed Bronze finish ties into the rest of the tapware and fittings used throughout the cottage, while the Charleston lever style adds a modern edge, beautifully matching the Buddy Tapware in Aged Brass Organic from Plumline NZ.

Scan the below QR code for more projects.





WINDSOR ARCHITECTURAL HARDWARE

AUS 1800 841 643
MELB 03 9116 7050
SYD 02 8011 1833

sales@windsorhardware.com.au

windsorhardware.com.au



Windsor
ARCHITECTURAL HARDWARE